

*Repairing
Your
Flooded
Home*

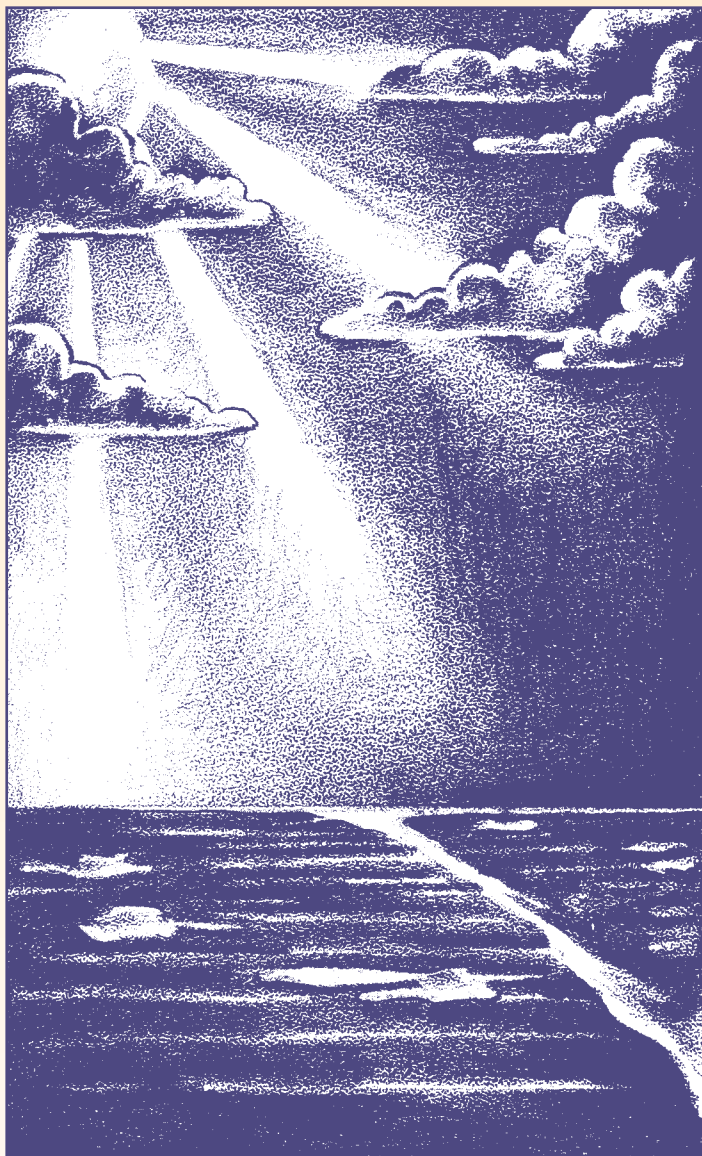

Contents

Step 1. Take Care of Yourself First	1
Protect yourself and your family from stress, fatigue, and health hazards that follow a flood.	
Step 2. Give Your Home First Aid	4
Once it is safe to go back in, protect your home and contents from further damage.	
Step 3. Get Organized	11
Some things are not worth repairing and some things may be too complicated or expensive for you to do by yourself. A recovery plan can take these things into account and help you make the most of your time and money.	
Step 4. Dry Out Your Home	14
Floodwaters damage materials, leave mud, silt and unknown contaminants, and promote the growth of mildew. You need to dry your home to reduce these hazards and the damage they cause.	
Step 5. Restore the Utilities	20
The rest of your work will be much easier if you have heat, electricity, clean water, and sewage disposal.	
Step 6. Clean Up	24
The walls, floors, closets, shelves, contents and any other flooded parts of your home should be thoroughly washed and disinfected.	
Step 7. Check on Financial Assistance	28
Voluntary agencies, businesses, insurance, and government disaster programs can help you through recovery.	
Step 8. Rebuild and Floodproof	32
Take your time to rebuild correctly and make improvements that will protect your building from damage by the next flood.	
Step 9. Prepare for the Next Flood	40
Protect yourself from the next flood with flood insurance, a flood response plan, and community flood protection programs. This step also includes sources to go to for additional assistance.	
Index	49
Important Phone Numbers	Inside Back Cover
Safety Precautions	Inside Back Cover

About This Book

This information is published by the Federal Emergency Management Agency (FEMA) and the American Red Cross to help flooded property owners. It is designed to be easily copied. Permission to reproduce all or any section of this material is hereby granted and encouraged.

Copies of this book are available from your local Red Cross chapter or by writing:

FEMA
P. O. Box 2012
Jessup, MD 20794-2012

Following A Flood

This book gives step-by-step advice you can use to clean up, rebuild, and get help after a flood. Before you start, read the safety precautions at the top of this document and review the nine steps that are summarized on the contents pages.

Your home and its contents may look beyond hope, but many of your belongings can be restored. If you do things right, your flooded home can be cleaned up, dried out, rebuilt, and reoccupied sooner than you think. While you are doing the job ahead, you should remember these three important points:

1. Play it safe. The dangers are not over when the water goes down. Read the safety precautions at the top of this document. Your home's foundation may have been weakened, the electrical system may have shorted out, and floodwaters may have left behind things that could make you sick. Many flooded items, such as wallboard and mattresses, will hold mud and contamination forever. When in doubt, throw it out. Don't risk injury or infection.

2. Ask for help. Many people can do a lot of the clean up and repairs discussed in this book. But if you have technical questions or do not feel comfortable doing something, get professional help. If there is a federal disaster declaration, a telephone "hotline" will often be publicized to provide information about public, private, and voluntary agency programs to help you recover from the flood. Government disaster programs are there to help you, the taxpayer. You're paying for them; check them out.

3. Floodproof. It is very likely that your home will be flooded again someday. Floodproofing means using materials and practices that will prevent or minimize flood damage in the future. Many floodproofing techniques are inexpensive or can be easily incorporated into your rebuilding program. You can save a lot of money by floodproofing as you repair and rebuild. See Step 8. You should also prepare for the next flood by buying flood insurance and writing a flood response plan.

Acknowledgements

This book was prepared for the Federal Emergency Management Agency under Contract Number EMW-89-C-3024 and EMW-91-K-3738.

FEMA and the American Red Cross gratefully acknowledge the thoughtful assistance provided by the many individuals who reviewed this book. Reviewers included repair and reconstruction contractors, mental health professionals, sociologists, researchers, disaster assistance specialists, insurance experts, underwriters, structural engineers, public health agents, floodplain managers, emergency managers, education specialists, editorial experts, and graphic designers.

STEP
1*Take Care of Yourself First*

You and your family have been through a disaster. Your life has been turned upside down, and it will take time for things to return to normal. Take a few minutes to review the safety and health precautions listed at the top of this document. Also, you should watch out for symptoms of anxiety, stress, and fatigue.

With all the cleanup and repair jobs awaiting you, it may seem odd to spend the first chapter of a flood recovery book talking about emotional issues. But a disaster can do damage beyond the obvious destruction and debris you see everywhere. You should recognize that the flood can take its toll on you as well as your property. This first section is designed to remind you that you need to look after yourself and your family as you focus on the obvious tasks of cleanup and recovery. Your hidden enemy is stress. Watch for it.

Care for Yourself

Your body reacts to stress in many ways. You may expect to experience one or more of the warning signs as you deal with the flooding and recovery. Your body is just reminding you that times are difficult. Reactions to stress are common and usually temporary. Need some relief? Here are some steps you can take to relieve your tensions.

Keep the family together

Even in bad times, togetherness provides mutual support for all members.

Discuss your problems. Talk to family and friends. Share your anxieties. Let others talk to you to help release tension. Crying is a natural response to a disaster. It's also a great way to release pent-up emotions.

Rest often and eat well. You are more likely to suffer from stress and health problems when you are weak. Being active helps, but don't overdo it. Your body must have proper rest and nourishment for you to keep going.

Set a manageable schedule. You have a million things to do, but you can't do everything at once. Make a list and do jobs one at a time. Establish a schedule to clean up and rebuild. Following the steps in this booklet will help you. Try to return to your pre-flood routines as quickly as possible. Routines give you something predictable to depend upon.

Watch for signs of stress. You have just been through a disaster and the recovery period can be long, hard, and chaotic. Don't be surprised if you experience tension or see signs of stress in family members. Often other people will notice problems more readily than you do. Listen to them.

Seek help. If you cannot shake feelings of despair or other telltale signs of stress, get professional help. Special outreach programs and crisis counseling are often set up following a disaster because so many people need help to cope with their situation. Contact the Red Cross for programs available in your area.

Warning Signs of Stress

- Short tempers, frequent arguments
- Greater consumption of alcohol
- Smoking more than usual
- Getting upset over minor irritations
- Difficulty sleeping, bad dreams
- Aches, pains, stomach problems
- Apathy, loss of concentration
- Depression

Helping Children

- Keep the family together
- Listen to them
- Explain what happened
- Reassure them
- Be understanding
- Take care of yourself

Floodproof as you rebuild.

People who are prepared ahead of time are better able to deal with disasters. Getting ready for the next flood can give you a sense of control over the future. Besides, floodproofing will be a definite improvement to your property.

Care for your children.

Watch your children closely. You can expect to see them display fear or symptoms of stress.

Fear is a normal reaction to any danger that threatens a person's well-being. Because their daily routine has been interrupted, children may experience considerable anxiety and fear. Those feelings are real and natural. You can help your children deal with the disaster by keeping in mind the following points.

Try to keep the family together. Make an effort to establish normal family routines. Include children in cleanup activities. Children need and want to be important parts of the family.

Listen to what children say. Encourage them to talk or otherwise express their feelings. Teenagers may need to talk with other teenagers.

Explain the disaster factually. Children have vivid imaginations and what they don't understand can make them fearful. Knowing the facts can help children deal better with the disaster.

Reassure children. Show them through words and actions that life will return to normal. Touching and holding are important. Hugs help. Try to find or replace pets or favorite toys.

Be understanding. Avoid scolding children for things that might be flood-related, such as bed wetting, thumb sucking, or clinging to you. Remember, they are also going through a rough time.

Take care of yourself. Your children reflect your fears and worries. If you take care of yourself, you will be better able to help your children cope.

Stay healthy

Infants, pregnant women, and people with health problems should avoid the flooded area until cleanup is complete. Small children tend to put things in their mouths. Pregnant women need to be cautious to avoid injury and exposure to disease. People with health problems are more likely to get sick or be injured.

The Red Cross can help you replace medicine or lost prescriptions after a disaster.

Your body is used to being clean. When you work in an area that has been flooded, you will be exposed to dangerous chemicals and germs that you are not used to and can make you very sick.

Wash your hands with soap and water, thoroughly and often. This is especially important before handling food, eating, or smoking. If possible, use an antibacterial soap on your hands. Avoid biting your nails.

Confirm that the water is clean and safe. Don't drink it or wash dishes until you're sure. (See Step 5).

Disinfect dishes and all items that floodwaters touched.

Instructions for cleaning and disinfecting appliances and household items are covered in Step 6.

Don't hurt yourself. Items are much heavier when wet. Don't try to move large objects by yourself. Unfortunately, injuries, especially back injuries, are a common side effect of cleaning up after a flood.

Watch out for fatigue. When your body is tired, you are more prone to accidents. Set a realistic schedule for the work you will do each day.

Be Safe Around Poisons. Many of the products you will use to clean, disinfect, and repair your home are poisons. Read and follow label instructions. And

keep all chemical products out of the reach of children. Have the number for your local Poison Control Center posted by your telephone and call right away if anyone is poisoned.

Report health hazards. Tell the Health Department about animal carcasses, rats, dangerous chemicals, and similar hazards on your property.

Be patient. Above all, try to be patient with your family, your neighbors, the local, state, and federal authorities, and volunteer agency personnel. Remember that many others are in the same situation you are in, and it may take time for everyone to get service. You may have to wait your turn.

Staying Healthy

- Wash up frequently
- Make sure the water is safe
- Disinfect everything
- Don't overdo it
- Report health hazards

STEP
2

Give Your Home First Aid

It is dangerous to go back into your home because the flood may have caused structural, electrical, and other hazards. After you have made things safe, take steps to protect your home and contents from further damage.

Most of the information in this section assumes that the person doing the work has experience in construction and electrical repair. *If you do not have experience in construction and electrical repair, do not try to do this work yourself. Hire a qualified contractor or an electrician.* It is still a good idea to read the information in this book so you will have a better understanding of the jobs ahead, no matter who does them.

Even if you have some experience with construction and electrical work, *do not attempt any job if you feel uncertain about the right thing to do or you wonder if the job is beyond your skill or physical strength.* Read the instructions in this book all the way through before you start. Gather your tools and supplies, and make sure you have enough help.

There is plenty of work to go around after a flood. Do only those jobs you can do well and without injuring yourself. If you cannot afford to get professional help, check with your Red Cross chapter, your local emergency management agency, or your building department to see if there are any volunteer programs available to you.

This section is designed for those who have experience in construction and electrical repair. If you are uncertain about these steps, contact a professional such as a licensed home repair contractor or an electrician.

Make Sure It Is Safe to Go Back

Some floods have more than one crest or peak. Even though the water looks like it's going down, it may rise again and trap you. Stay tuned to your radio or TV to find out if and when you can go back home. If you are not sure whether you can return, contact your local emergency manager.

Read the safety precautions at the top of this document. Each year about 150 people die because of floods. Many of those fatalities are due to electrocution or other accidents that occur after the floodwaters have gone down. *Have someone with you ask you check your home and do repairs.* Dress for the task—wear sturdy shoes and gloves.

Things You will Need When It Is Safe to Return Home

- Flashlight
- First aid kit
- Battery-operated radio
- Waterproof boots or waders
- Safety clothing, such as a hard hat and gloves
- Boots or shoes with hard soles
- Dust mask

A Note About Portable Generators

Portable generators can be a big help if you are without power. But remember:

- Connect appliances one at a time to the generator. Never hook a generator directly to your household wiring yourself. Only a qualified electrician can do this.
- Use generators outdoors only. They give off carbon monoxide fumes.
- Avoid using extension cords with generators. If you must use them, check them often to make sure they have not become hot.

- Camera or video camera to record damage
- Tools: crowbar, hammer, saw, pliers, crescent wrench, screw drivers, etc.
- Drinking water
- Trash bags
- A wooden stick for turning things over, scaring away snakes and small animals, and moving electrical wires
- Cleaning supplies

Note: do not use candles before, during, or after a flood. Candles can easily tip over or invite child fire-play.

Check Your Home Before You Go In

If there is standing water next to the outside walls of your home, don't go in. You won't be able to tell if the building is safe or structurally sound. Before you go in, walk carefully around the outside of your home and check for loose power lines and gas leaks. You will know there is leaking gas by the putrid, distinct odor that is added to gas to let people know gas is leaking. If you find downed lines or leaks, call your utility company.

Check the foundation for cracks or other damage. Examine porch roofs and overhangs to be sure they still have all their supports. Look for gaps between the steps and the home. If you see obvious damage, have a building inspector check the home before you go in. Some communities require official inspections for all buildings after a flood.

If any supports or portions of the foundation wall are missing or

the ground has washed away, the floor is not safe. If you have any doubts about safety, contact a contractor before going in. *Proceed very carefully.*

Turn off the electricity

Electricity and water don't mix. *Turn the power off at your home!* Even if the power company has turned off electricity to the area, you must still make certain your home's power supply is disconnected. You don't want the power company to turn it on without warning while you're working on it.

The electricity must be turned off at the main breaker box or fuse box. Your utility company may have removed your electric meter. *This does not always turn off the power.*

If you have to step in water to get to your electric box, call an electrician. Simply removing the electric meter does not always turn off the power. If you can get to your electric box without going through or standing in water, you can turn off the power yourself. (See box).

Remember that if the electrical or gas controls are inside the home, *do not* turn them off until you can *safely* enter your home.

Turn off the gas

Gas appliances and pipes may have moved or broken during the flood, creating a gas leak. If you suspect a leak or smell gas, leave your home immediately and call the gas company from a neighbor's home. Leave the door open and, if the gas meter is outside, turn off the gas.

How to Turn Off the Power

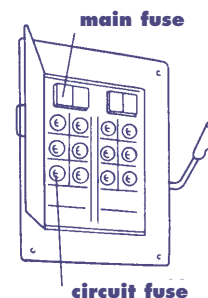

Fuse Boxes

1. Stand on a dry spot.
2. If your box has a handle on the side, use a dry wooden stick or pole to pull the handle to OFF.
3. Use the stick to open the door.
4. Carefully pull out the main fuses. Use a dry wooden stick.
5. Unscrew and remove each circuit fuse

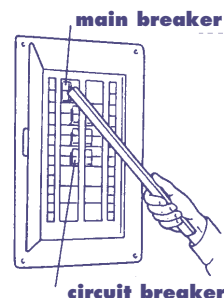

Breaker Boxes

1. Stand on a dry spot.
2. Use a dry wooden stick or pole to open the door.
3. Use the stick to push the main breaker switch to OFF.
4. Use the stick to turn each circuit breaker to OFF

Safety Checklist

- Wait for the water to go down
- Report downed power lines
- Report gas leaks
- Check for structural damage
- Turn off electricity
- Turn off gas or fuel

If you have gas appliances that were flooded, you will need to clean the mud out of the pilot and the burners. But first, you must turn off the gas.

There is a valve next to the gas meter. If the valve handle is parallel to the pipe, the gas is on. You may need a pair of pliers or a wrench to turn the valve. Turn it 90 degrees (a quarter turn) so the handle is perpendicular to the pipe to shut the gas off.

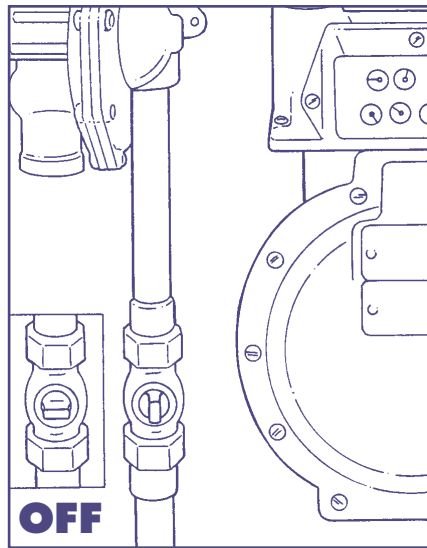

Some gas meter valves will have a hole in the handle. This hole lines up with a hole in the valve body when the gas is shut off. (The gas company uses the hole to lock or seal the valve closed when the building is vacant.) When the holes are lined up, you know that the gas supply has been shut off.

To be sure the gas is off, write down the numbers on all the dials in the meter. Check the dials at least five minutes later. If the numbers have changed, the valve is not closed. Gas is still flowing. Telephone your utility company

for help and keep clear of the area until the gas has stopped flowing.

If you have a fuel oil or propane tank, it may have floated and broken the connecting pipes. Even an underground tank can float. Turn off the fuel valve at the tank and follow the instructions in Step 5 before you turn the fuel back on.

Go Inside carefully

If the door sticks and has to be forced open, it is probably swollen. If it only sticks at the bottom, it can be forced open. If it sticks at the top, your ceiling may be ready to fall. You can force the door open but wait outside the doorway for a minute where you will be protected if something falls.

If the door won't open easily, it may be easier for you to enter your home through a window. Look carefully at the ceiling before you go in to be sure it is not ready to fall.

Do not smoke or use candles, gas lanterns, or other open flames in your home. Air out your home completely—there may be explosive gas.

Check the ceiling for signs of sagging. If there was a lot of wind and rain or if the flood was very deep, your ceiling may be holding water. Wet plaster or wallboard is very heavy and dangerous if it falls. If the ceiling is sagging, do the following before you go in:

1. Make a poker by attaching a nail or other pointed object to the end of a long stick. (You might hammer a finish nail into the end of a broomstick.)

2. Stand away from, not under, the sag. (Under a doorway is safest.) Poke a hole in the ceiling at the *edge* of the sag so any trapped water can begin to drain. Do not start at the center of the sag because the ceiling may collapse suddenly.

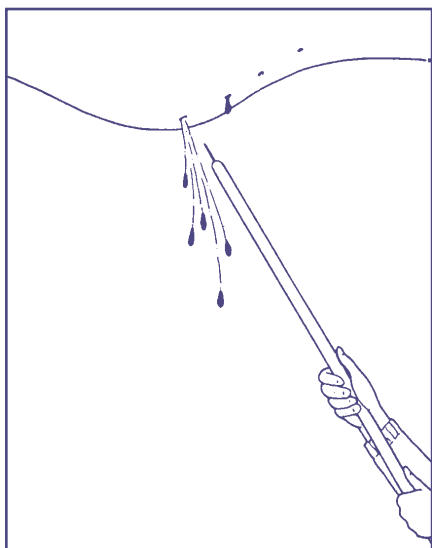

3. After the water drains, poke another hole, lower down the sag. Keep poking holes as you move to the lowest point.
4. Tear down the sagging ceiling using extreme caution—it's very heavy. You'll have to replace it anyway.
5. Repeat this procedure for any room that has sagging ceilings.

Step carefully. Water and mud make a floor very slippery. Also watch for snakes, other animals, loose flooring, holes, and nails.

Check for cabinets and other tall pieces of furniture that might be ready to fall over. Remove mirrors and heavy pictures from walls. They will not stay up if the wallboard is wet.

Rescue the Most Valuable Items

Find and protect the “irreplaceable” valuables such as money, jewelry, insurance papers, photographs, and family heirlooms. Wash the mud off before the items can dry. Put articles in a safe place such as a dry second story or a plastic bag, or take them to a friend's home.

Photographs, books, and other articles that are easily damaged when wet can be frozen and cleaned later when you have more time. Wash the mud off. Store the articles in plastic bags and take them to a friend who has electricity. Put them in a frost-free freezer to protect them from mildew and further damage until you have time to thaw and clean them. A photographer or camera shop can professionally clean wet photographs.

Resist the urge to stop and clean everything you pick up. You need to get to work on protecting your home, assessing all the damages, and planning your recovery so you can save and restore as much as possible. You can clean up your belongings *after* you have done the more important things listed here.

Protect Your Home From Further Damage

You need to make sure that there will be no more damage from rain, wind, or animals. Your flood insurance policy may cover some of the cost of protecting your home from further damage or moving the contents to a safe place. (Read your policy and ask your agent what expenses are covered by your policy.)

Get fresh air moving through your home. Open windows and doors if weather permits. This will reduce the moisture and get rid of any gas in the home. Do not try to force open a swollen window. Instead of breaking glass, remove the molding and take the window sash out of its frame.

Patch holes. Cover holes in the roof, walls, or windows with boards, tarps, or plastic sheeting. Plastic sheets or trash bags should be nailed down with wood strips or taped with duct tape to keep them from ripping loose. It may not look pretty, but you need to do this so rain won't cause any more water damage.

Repair sagging floors or roof sections. Use 4 x 4's or other heavy lumber to brace weak areas. If you're uncertain how to shore up floor or ceiling joists, call a contractor.

Remove debris. Tree limbs or other trash that may have landed on or floated into the home should be cleared away.

Check for broken or leaking water pipes. If you find any, cut off the water supply by turning off the valve at your water meter. If you can't find it, call the water company for help. Also check floor drains—they may be clogged with debris.

If the water pipes are not leaking, you can use your tap water for hosing and cleaning. But *do not drink or cook with tap water until it has been declared safe.* (If you are not on a municipal water system, the local health department will usually inspect your well and test your water. See Step 5.)

Drain Your Basement Carefully

If your basement is flooded, don't be in too big a hurry to pump it out. Here's why.

Water in the ground outside your home is pushing hard against the outside of your basement walls. But the water inside your basement is pushing right back.

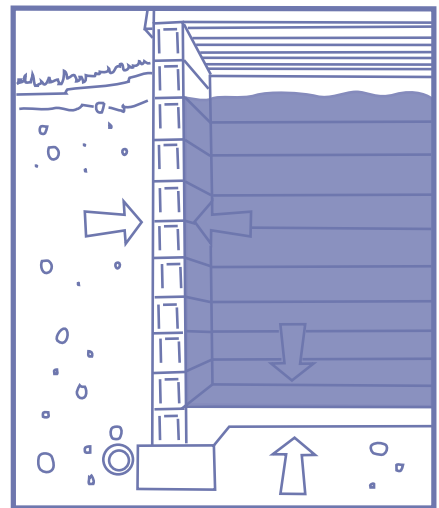

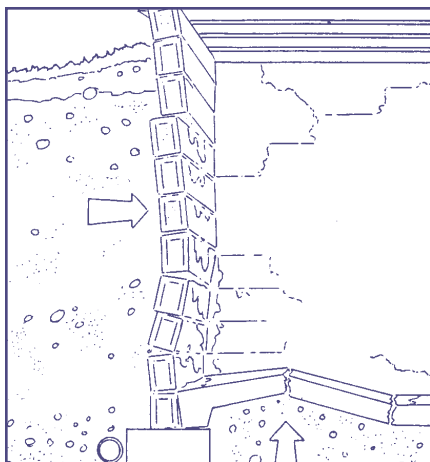

If you drain your basement too quickly, the pressure outside the walls will be greater than the pressure inside the walls—and that may make the walls and floor crack and collapse, causing serious damage.

To avoid this situation, follow these steps when you pump the water out of your basement:

1. Never go into a basement with standing water in it unless you are sure the electricity is off.
2. After floodwaters are no longer on top of the ground, you can start pumping the water out of the basement. Do not use gasoline-powered pumps or generators indoors because gasoline engines create deadly carbon monoxide exhaust fumes.
3. Pump the water level down two to three feet. Mark the level and wait overnight.
4. Check the water level the next day. If the water went back up, it's still too early to try to drain the basement. Wait overnight. Then pump the water down two to three feet again. Check the level the next day.

5. When the water stops going back up, pump down another two to three feet and wait overnight. Repeat steps 4 and 5 until all water is pumped out of the basement.

Hose the House and Its Contents

The mud left behind by floodwaters contains most of the health hazards you will face. It is very important to get rid of the mud as soon as possible. This is a lot easier if it is done before the mud dries out. Follow these steps:

1. Shovel out as much mud as possible.
2. *Make sure the electricity is turned off.* Unplug all appliances and lamps, remove all light bulbs, and remove the cover plates to wall switches and outlets that got wet. Check with your local building department to see if your code allows you to disconnect the wiring from the switches and outlets.

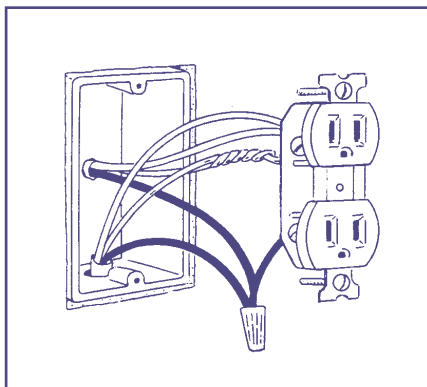

If the code does not allow you to disconnect them, leave the wires connected and pull them out of their boxes as shown in the drawing. They can be replaced during Step 5 by an electrician.

Health Precautions

- Assume that anything touched by floodwaters is contaminated.
- Wash hands frequently.
- Disinfect everything floodwaters have touched

If the code permits, it is probably best to throw away switches and outlets that were flooded and replace them with new ones. (See Step 5).

3. Check your water system for leaks from pipes that may have moved. (See Step 5). Even if your water supply is not safe to drink, it can be used for cleaning the home. If you have water, hose the home down, inside and out. If you have an attachment that sprays soap, wash and then rinse the walls and floors. Hose the furniture, too, and other major items that got muddy.
4. Heating and air conditioning ducts that got flooded will have mud left in them. If you don't clean them out, your system will be blowing foul, dusty air that contains the same health hazards you are trying to get rid of. To clean the ducts, remove the vents or registers. If possible, remove some sections of the ducts in the basement or crawl space to give you access to all areas. Then thoroughly hose out all the ducts.
5. While you hose the walls, thoroughly hose out the electrical outlet, switch boxes, and light sockets that you opened up. Follow the steps (found later in this document) before turning the electricity back on.
6. After you hose out the duct work to remove the mud, wash it with a disinfectant or sanitizer, such as the quaternary, phenolic, or pine oil based ones. (Check labels for the contents and instructions). If your ducts are in a slab or are otherwise inaccessible, have them cleaned by a professional.
7. Don't let the water sit on the floor for long, especially if your floor has particle board or other wood product that tends to fall apart when wet. Use a mop, "wet vac," or squeegee.

STEP 3 Get Organized

Before you try to clean up and repair everything, you need to assess your damage and develop a recovery plan. An organized approach will make the best use of your time and money. If your structure is substantially damaged, you need to ask yourself if you should rebuild at all—it may be smarter, safer, and cheaper to relocate. If you do rebuild, your recovery plan should include the floodproofing measures that can be incorporated with repairs and can save you thousands of dollars in the future (see Step 8).

Call Your Insurance Agent

You need to tell your agent about the damage to your home and contents so that your agent can file a claim. The sooner you can talk to your agent, the sooner your claim will be filed and an adjuster will be assigned to review your damage. How much of your loss is covered will depend on your policy. But even if you don't have full coverage, your agent may be able to give you advice about where to get help with cleanup and repairs.

Your property insurance will fall into one of three categories:

1. Homeowner's insurance

usually covers losses caused by wind, storm, or broken water pipes, but not surface flooding. Some homeowner's policies may cover basement flooding caused by sewer backup or sump pump failure.

2. Flood insurance covers most losses caused by surface floodwater.

3. Wind and hail insurance

covers losses in coastal areas from the winds of a hurricane. In coastal areas, homeowner's insurance often does not cover damage from wind.

Read your insurance policies so that you will know what is covered and what is not. If your insurance covers the damages, your agent will tell you when you can expect an adjuster to contact you. The adjuster will determine the costs to repair the damage to your home and your belongings. The adjuster will then submit those costs to the insurance company for final approval. Your agent will also tell you what to throw away, and what to set aside for the adjuster to review. Find out if your insurance covers living expenses while your home is being repaired. (Flood insurance does not cover that cost.)

Start listing the damage

List the damage and take pictures or videotapes as you clean up so you will have a complete and thorough record. Good records are needed for insurance claims, applications for disaster assistance, and income tax deductions.

Some items that are health hazards, such as rotting food and debris, should be thrown away.

Records to Keep

- Damage to the building
- Damage to the contents (see sample inventory form, next page)
- Receipts for cleanup and restoration expenses, such as material, labor, and equipment rental, and receipts for flood-related expenses, such as motel bills. (Keep these in one place, like in an envelope in your car.)

Tell your agent or adjuster that you need to get rid of this trash before you throw it out. They should tell you what to do so that all of your losses can be recorded properly by the adjuster. (See other pages in this document on sorting items to discard.) You may be told to keep a sample of items such as a piece of carpet or upholstery to show the value of what you have thrown away.

LIVING ROOM CONTENTS				
QUANTITY	ITEM	YEAR PURCHASED	COST/VALUE	
1	COUCH	1985	\$ 700	HOSE OFF, SET ASIDE FOR ADJUSTER
1	WALL TO WALL CARPETING	1980	\$1200	CUT A SMALL SAMPLE THROUGH OUT BEST
1	POSSIBLE INHERITED		EST \$100	CLEAN UP
5	SHELVES	PAINT BY ME	EST \$200	CLEAN UP
20	WICKERS	1975	\$200	HOSE OFF, SAVE FOR ADJUSTER
TOTAL LIVING ROOM CONTENTS EST. \$ 3,200				

Ask someone to sign your record as a witness. If you have flood insurance, you will need to file a Proof of Loss form within 60 days of the flood. (See Step 7). Completing your own inventory form will make this form easier to complete and will also help the adjuster determine the costs to repair the damage to your home and belongings.

Check for Structural Damage

You need to find out whether there is any structural damage to your home. (You will probably need professional help in making this decision.)

Is there evidence of broken or cracked basement or foundation walls? Are there broken pilings, shifted stairs, or slanted floors or walls? Any of these things could mean that the foundation, floors,

or walls will have to be totally rebuilt. Repair safety hazards such as broken pilings or an undermined foundation before you proceed any further. Get professional help for any task you cannot confidently do yourself.

You will need a building permit to repair structural damage. Talk to your building department before you start reconstruction or sign any repair contracts. If the damage to your home's structure exceeds 50% of the market value of your home, most local building codes will require you to elevate it above flood levels. Some may not allow you to rebuild at all. (For more information on building permits, See Step 8.)

Ask the Big Question

Odds are that the area where you live will flood again. Before you spend a great deal of money and effort repairing and rebuilding, ask yourself this question:

Do I really want to be flooded again?

If you think that you would be better off in a different location, talk to your local government or disaster assistance officials about help rebuilding where floods can no longer damage your home.

There are programs that will buy some properties with houses that have been destroyed or substantially damaged. Other programs give financial help to move or elevate houses so they are above flood levels. See Step 7 for more information on flood-proofing assistance programs.

If you decide to stay, you can still make your home less susceptible to damage from the next flood. Before you start repairing and replacing things just like they were before, look at the floodproofing measures in Step 8. Floodproofing as you repair and rebuild can save a great deal of money over time. Protecting your home from future floods will also add value to your property.

Plan Your Recovery

Get organized with a recovery plan. A recovery plan is simply a list of jobs that need to be done. Planning can help you save time and money. Doing things in the right order will also make everyone feel better—you'll know you are making progress without wasting effort.

To develop a recovery plan, follow these steps:

- ✓ **Make sure it is safe to work in your home.** You'll want to go back to your home as quickly as possible. But you must make sure the building is safe and sound. (See Step 2).
- **Review the rest of the recovery steps in this book.** Start making lists. Begin with the projects such as "replace furnace" and "dry out walls." Write down items you will need such as cleaning supplies or film and paper for record keeping. If necessary, make plans for a place to stay while you clean up.
- **Decide what you can and can't do.** You can save money by doing much of the work described in this book as you can. But be realistic. Jobs such as propping up broken foundations and replacing electrical

service boxes are best left to the professionals. Many other jobs may be too involved or too heavy for you.

- **Decide if you need financial assistance.** If you need to replace items or hire a professional and you don't have insurance, there may be some voluntary organizations that can help you. (See Step 7.) Check the local newspaper, radio and TV stations for notices about Red Cross, church, and government disaster programs.
- **Check with your mortgage holder.** If your mortgage holder is listed on your insurance policy, you cannot cash your insurance claim check without their approval. Before you decide on repairing and floodproofing, make sure that your loan will not be affected. The mortgage holder may be able to provide financial help, such as deferring interest payments for a month or two.
- **Think before you use credit cards.** Credit cards may be the fastest way to handle repair and rebuilding expenses, but they are also very costly. Their interest rates can be up to two percent per month (24 percent per year). A second mortgage or low interest government loan is a much less expensive way to borrow money for home repairs.
- **Keep talking openly with your family.** Some of the biggest problems that come with a disaster are the mental strain of the loss and worries about the future. Work together and let everyone know what you will be doing in the days ahead.

Cleanup and Repair— Who does what?

Jobs an owner can usually handle by following the steps in this book

- Sorting contents to be repaired or discarded
- Drying the ceiling, walls, and floors
- Drying and cleaning electrical circuits and boxes (if code allows)
- Removing minor debris such as branches and trash
- Checking the gas or oil system
- Fixing leaky pipes
- Checking sewage disposal system
- Building and contents cleaning
- Checking sources of financial assistance
- Minor floodproofing projects such as building an earthen wall or raising appliances

Jobs that usually require services of a professional

- Structural repairs
- Restoring electrical service
- Wallboard taping and finishing
- Checking the water system to ensure that it is safe to drink. (That service is often free from the local health department.)
- Major debris removal such as tree cutting
- Electrical and gas appliance and motor cleaning and repair
- Cleaning leather, furs, upholstered furniture, and expensive carpeting
- Major floodproofing projects such as moving or elevating a home

STEP
4

Dry Out Your Home

Floodwaters affect a home three ways:

- 1. The water damages materials. Wallboard will disintegrate if it remains wet too long; wood can swell, warp, or rot; electrical parts can short out, malfunction, and cause fires or shock.*
- 2. Mud, silt, and unknown contaminants in the water not only get everything dirty; they also create a health hazard.*
- 3. Dampness promotes the growth of mildew, a mold or fungus that can grow on everything.*

The following steps work on all three of these problems. It is very important that they be followed in order.

Lower the Humidity

Everything will dry more quickly and clean more easily if you can reduce the humidity in the home. There are five ways to lower the humidity and stop the rot and mildew. But you'll have to delay using some methods if you have no electricity. (Read Step 5 before you attempt to restore the utilities.)

- Open up the house.** If the humidity outside is lower than indoors, and if the weather permits, open all the doors and windows to exchange the moist indoor air for drier outdoor air. Your body will tell if the humidity is lower outdoors. If the sun is out, it should be drier

outside. If you have a thermometer with a humidity gauge, you can monitor the indoor and outdoor humidity. On the other hand, when temperatures drop at night, an open home is warmer and will draw moisture indoors. At night and other times when the humidity is higher outdoors, close up the house.

- Open closet and cabinet doors.** Remove drawers to allow air circulation. Drawers may stick because of swelling. Don't try to force them. Speed drying by opening up the back of the cabinet to let the air circulate. You will probably be able to remove the drawers as the cabinet dries out.
- Use fans.** Fans help move the air and dry out your home. Do not use central air conditioning or the furnace blower if the ducts were under water. They will blow out dirty air, that might contain contaminants from the sediment left in the duct work. Clean or hose out the ducts first. (See Step 2.)
- Run dehumidifiers.** Dehumidifiers and window air conditioners will reduce the moisture, especially in closed up areas.
- Use desiccants.** Desiccants (materials that absorb moisture) are very useful in drying closets or other enclosed areas where air cannot move through.

Desiccants like those listed below are usually available at hardware, grocery, or drug stores.

- Chemical dehumidifier packs used for drying boats and damp closets.
- Cat litter made of clay.
- Calcium chloride pellets used for melting ice in the winter. Hang pellets in a pillow case, nylon stocking, or other porous bag. Put a bucket underneath to catch dripping water. Close the closet or area being dried. Be careful. Calcium chloride can burn your skin. It will also make the air salty, so do not use this product near computers or other delicate equipment.

☐ Call a contractor. There are contractors who specialize in drying out flooded buildings. They have large fans and dehumidifiers that can dry out a house in a few days. Look in the yellow pages under Fire and Water Damage Restoration or under Dehumidifying. Be careful about contractors who inflate prices after a disaster and about out-of-town contractors who inflate prices after a disaster and about out-of-town contractors who request payment in advance.

Be patient. Drying your home could take several weeks. Until your home is reasonably dry, damage caused by mildew and decay will continue. The musty odor will remain forever if the home is not thoroughly dried out well.

Sort Contents and Discard Debris

You have three types of contents that should go to three different places:

- items you want to save
- items to be discarded
- garbage

Things you want to save

Move these to a safe, dry place, such as the second story or outside. The longer they sit in water, the more damaged they become. In some cases, you may only be able to move them to one room while you clean the other rooms. Don't leave wood furniture in the sun or it will warp when it dries. To save an area rug, lay a sheet or some other material on top so the colors will not bleed. Clean it promptly.

Things you don't want to save

Put things you don't want to save outside to dry until the adjuster comes to confirm your losses. Take pictures or videotapes and list each item for the record. If you are not sure whether to throw something out, decide whether it is worth salvaging by checking the information in Step 6.

Garbage

Get rid of food and anything else that could spoil or go bad immediately. Don't let garbage build up. Garbage piles will cause yet another health hazard by attracting animals and insects. If your insurance adjuster has not come, tell your agent or adjuster that you need to get rid of potential health hazards. That person will tell you

Items Soaked by Floodwater

Should I Throw them Out?

Usually

Mattresses, pillows, foam rubber, large carpets, carpet padding, upholstered couches and chairs, books, paper products

Always

Food, cosmetics, medical supplies, stuffed animals, baby toys

Questions about the Safety of Your Food?

Call the USDA Food Safety Hotline: 1-800-535-4555
Professional home economists will answer your questions from 10 a.m. to 4 p.m. eastern time, Monday through Friday.

Questions About the Safety of Your Food?

Call the USDA Food Safety Hotline: **1-800-535-4555**

Professional home economists will answer your questions from 10 a.m. to 4 p.m. eastern time, Monday through Friday.

how to make sure that your losses are covered. Then throw the stuff out, preferably in sealed plastic garbage bags.

Don't take chances with frozen food if electricity went off unless food is still thoroughly frozen and contains ice crystals. As a rule, food will remain frozen for up to three days in a closed freezer without power. Don't refreeze thawed food. However, you can cook and then freeze raw meat that was partially thawed and then refreeze it.

Dispose of discarded items properly. Do not burn or bury them. There will usually be more frequent garbage pickups after a flood. Your local TV and radio stations will have announcements concerning trash pickup schedules and drop-off sites.

How Floodwaters Affect Your Home

Once contents and debris have been cleared, the next step is to get the water out of the ceilings and walls. How you drain and dry your ceilings and walls depends on what they are made of.

Wallboard.

Most ceilings and walls are covered with wallboard, especially in newer homes. Wallboard will act like a sponge, drawing water up above the flood level. It becomes very fragile if it stays wet for long and will fall apart when bumped. When the wallboard finally dries, there will still be mud and contaminants dried inside.

Wallboard that has been soaked by floodwater presents a permanent health hazard. Therefore, this book recommends that you

throw out flooded wallboard. On the other hand, if the wallboard was soaked by clean rainwater, it can be dried in place with plenty of fresh air moving through the area.

Plaster.

Plaster will survive a flood better than wallboard. It should not have to be replaced but it will take a *very* long time to dry.

Sometimes the plaster will separate from the wood laths as it dries. Then the wall will have to be removed and replaced.

Insulation.

There are 3 main types of insulation and each reacts differently to floodwaters. Styrofoam survives best; it may only need to be hosed off.

Fiberglass batts should be discarded if they are muddy. If soaked by clean rainwater, remove them so the rest of the wall can dry. They can be put back in the wall, but it will take a very long time to dry.

Cellulose (loose or blown-in treated paper) insulation will hold water for a long time. It can also lose its antifungal and fire retardant abilities. Therefore, flooded cellulose insulation should be replaced.

Wood.

If allowed to dry naturally, wood will generally regain its original shape. Different layers of laminated wood, such as plywood, may dry at different rates, causing the layers to separate.

Water and Wood

Wood always has some water in it, but a flood can bring its moisture content up to 30 percent. This causes swelling. However, if allowed to dry naturally, wood will usually go back to its original shape. Unlike wallboard, wet studs and sills that are touched by floodwaters do not need to be thrown out. Hollow wood doors usually have cardboard spacers in the middle that lose their shape when wet. Generally, these doors come apart after they are flooded and need to be replaced.

Some contaminants will stay in the wood pores after it dries, but not as much as stays in flooded wallboard. Wood studs and sills will be covered by new wallboard and painted, so they are well removed from human contact. Therefore, wet wood studs and sills do not need to be replaced if they are allowed to dry properly.

Drain the Ceilings and Walls

Ceilings

Check for sagging ceilings. Drain them carefully as shown in Step 2. If the floodwaters went above your ceiling, you should replace it if it is made of wallboard. A plaster ceiling will dry eventually, but if it has too many cracks or sags, you will have to tear it down and replace it. Remove any wet insulation in the ceiling to allow the joists to dry.

Walls

Remove water trapped within your walls. To check for water, take off the baseboard. Stick an awl or knife into the wall about 2 inches above the floor (just above the 2 X 4 wood sill plate). If water drips out, cut or drill a hole large enough to allow water to drain freely. (Use a hand or cordless drill or saw to avoid shock.) If you are going to replace the wallboard anyway, you don't have to be neat: use a hammer to knock out a hole.

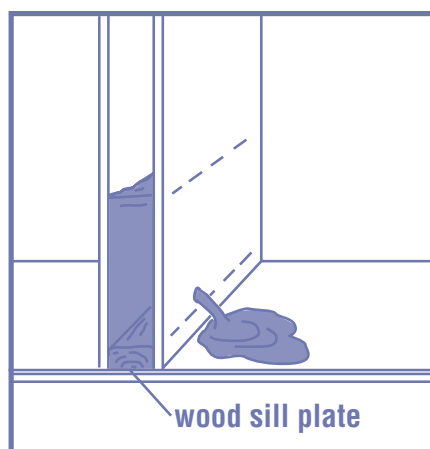

If your walls are plaster, a knife won't penetrate them. Drill a hole above the sill plate to drain the water. (Use a hand or cordless drill to avoid shock.) Do not use a hammer or chisel on plaster because the plaster could shatter.

In a newer home, you may have metal sill plates. A metal sill acts as a trough at the bottom of the wall cavity. Drill a hole at floor level to drain the water, using a hand or cordless drill.

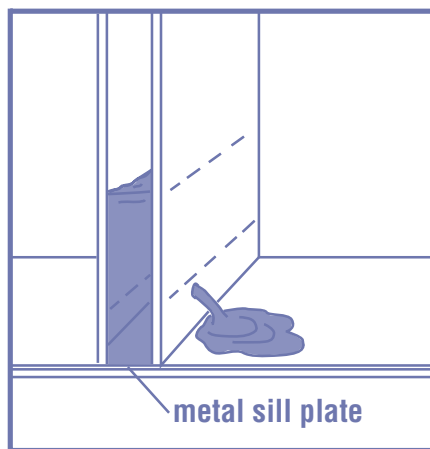

Repeat the process to drain all the wall cavities. Depending on the spacing between studs in your walls, make a hole every 16" or every 24". Watch out for the wiring which is usually at the

same height as your electrical outlets. If there is wet insulation, you will have to remove the wallboard in order to take out all the insulation.

Dry the ceilings and walls

Flood soaked wallboard is usually removed and thrown away. Plaster and paneling can often be saved, but you still need to get air circulating in the wall cavities to dry the studs and sills. Different approaches are used for different materials.

Wallboard

If floodwaters soaked the wallboard at least four feet above the floor, you should take down all the wallboard and replace it. If the water level was less than four feet deep, remove the lower four feet of wallboard. You can fill the gap with 4' x 8' sheets installed sideways.

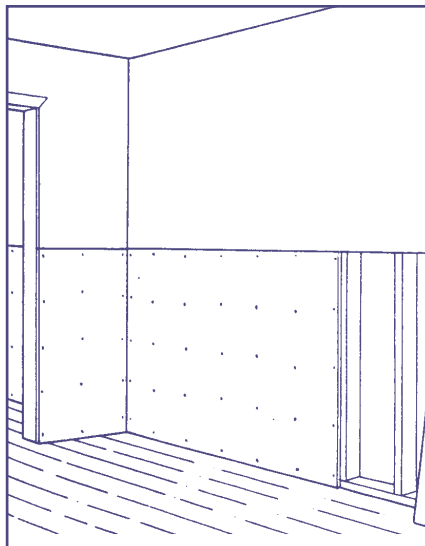

If you have Styrofoam insulation—or no insulation—and the wallboard was soaked with clean rainwater, you can dry the walls

without removing the wallboard using the technique explained below for plaster walls. But you will need to remove wet insulation if it is not Styrofoam.

Plaster walls

If the plaster or wallboard is clean and in good shape, you can drill or cut ventilating holes in each wall cavity. Place holes low enough so they will be covered by the baseboard after the wall dries out. Open up the wall on both sides of interior walls. For exterior walls, drill or cut holes on the inside of the house. However, if there is wet insulation, you will have to remove the plaster or wallboard in order to take out all the insulation.

Concrete block

The cavities in a concrete block wall will drain on their own. The water will not damage the concrete like it will wood or wallboard.

Wallcovering

Vinyl wallcovering seals the wall and prevents drying. Wallpaper paste is a favorite home for mold and mildew. For these reasons, you should remove all wallcovering that got wet and throw it out. (If vinyl wallcovering is loose on the bottom, you may be able to save it by pulling it off the wall up to the flood level. Clean and reapply it after everything dries.)

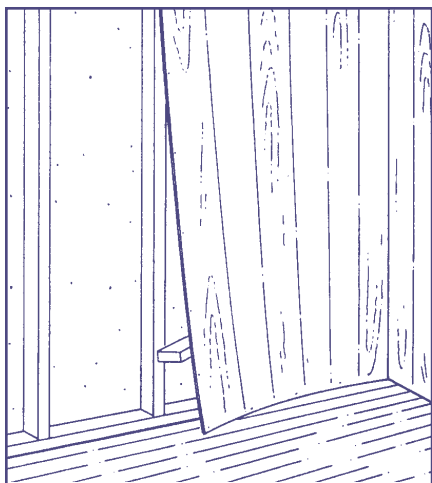

Paneling

Carefully pry the bottom of each panel away from the wall. Use something to hold the bottom away from the sill so the cavities can drain and dry out. You can nail them back into shape after they and the studs dry out. However, if there is wet insulation, you will have to remove the paneling in order to take out all the insulation.

Dry the floor

Air needs to circulate around flooded floors so they can dry out. This means removing the floor covering. Because floodwaters contain mud and dirt, most soaked floor coverings should be thrown away. Keep a piece of all discarded floor covering so the adjuster can tell its value.

Air needs to circulate below the floor to dry it out. If the crawl space of your home is flooded, pump it out. Remove any plastic sheets, vapor barriers or insulation from underneath the floor. (Be sure to replace them when the floor and foundation are completely dry.)

If a home with a basement was flooded over the first floor, remove finished basement ceilings, or cut or drill holes between all the joists to allow circulation. Don't cut or drill near electric lines or pipes. You have now reached the stage where no more damage should occur to your home. Exterior holes have been patched, the utilities have been turned off, and the drying process has started. It may take days or weeks, depending on the humidity, for all the wood to dry out. You can do Steps 5, 6, and 7 while the home is drying. However, do not start Step 8, Rebuild and Floodproof, until the home is completely dry.

Cleaning floor coverings

- Small throw rugs can be saved and cleaned in a washing machine.
- Indoor-outdoor carpeting can be hosed off and hung up to dry.
- Large rugs and those with foam backing should be discarded. (Usually only valuable carpets are worth the cost of professional cleaning.)
- After getting wet, wall-to-wall carpeting usually will not return to its former size and has to be thrown away. Therefore, make the job easier by cutting it in strips and discarding it in pieces that are small enough to be carried. Watch out for the tack-down strips along the wall; they often have nails sticking up to hold the carpet down.
- A wall-to-wall carpet that was soaked by clean rainwater can be left in place and dried.
- Remove tile, vinyl, and linoleum flooring should be removed if it is warped, loose, or has a foam rubber pad (which should be thrown away).

5
STEP

Restore the Utilities

Leaky Pipes

1. Check for leaky fuel pipes by smelling for gas. A chemical that has a disagreeable, distinctive odor is added to natural gas and propane to tell you if there is a leak. If you have any doubts, have a professional check for you. Do not use open flames.
2. Make sure the valve that leads to each appliance is closed.
3. If you find any pipes that moved or any area that smells like gas, brush soapy water on each pipe connection. The pressure in the pipes will make bubbles appear where there is a leak.

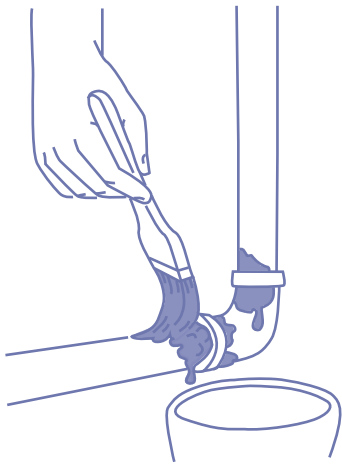

4. If you find a leak, turn off the gas. Unscrew the pipe connection, clean the joint, and apply pipe joint compound or pipe tape (available at hardware stores) on the threads. Screw the pieces back together tightly.
5. Turn on the gas and check the connection again with soapy water. If you have a leak, or if you are not sure your system is safe, turn off the gas and call a professional immediately.

The rest of your work will be much easier if you have heat, electricity, clean water, and sewage disposal. However, it may take some time for a repair professional to come. Therefore, you should go to Step 6 and do all the cleaning you can do while you wait for one or more of these utility systems to be restored.

Gas and oil systems

If your furnace, water heater, stove, or other gas or oil appliances were flooded to the level of the burners, turn off the valve on the pipe to the appliance. If they were hot when flooded, parts may have cracked. Flood insurance and federal disaster assistance programs will help replace flooded gas and oil appliances. If you want to keep a gas or oil appliance, have it cleaned professionally.

A cracked, plugged, or leaky chimney can cause fires or carbon monoxide poisoning. Be sure you check metal and brick chimneys for dirt, debris, and leaks before lighting the furnace or a fire.

Gas System

If the gas has been turned off at the main valve serving your home, you need to have a professional restore gas service to your home, relight pilot lights, and do a final check of the system.

If the gas valve serving only one appliance is turned off, then you can relight that appliance. First,

make sure the room is well-ventilated and that there are no open flames (or bare electric wires) anywhere. Then turn on the gas valve. Check for leaky pipes (see below). Let the gas run for a minute or two to clean any air and impurities out of the pipes. Then turn the gas off for a minute to allow the gas in the air to go away before you light the appliance.

Oil System

Make sure your main oil valve is turned off. Check your oil pump. If it got wet, have the pump professionally checked and cleaned. If you want to clean it yourself, see Step 6

Look carefully for any signs of leaking oil; if you see any, call a professional. Look for signs that the pipes or oil tank moved during the flood. Oil tanks, even buried ones, will float when flooded. After you have turned the electricity back on, open the main valve and turn the pump on. Check for leaky pipes. (See above.)

Propane, L-P, and Butane Systems

These fuels are kept in pressurized tanks, so there is no electric pump to turn on. Check the tanks for signs of movement or floating. Then follow the instructions above for gas systems.

Electrical System

Check with your building or electrical inspector to see how much work you can do on your wiring. Many local codes require that a licensed electrician do the work, or that a municipal inspector check the system before you can turn the power back on.

The electrical system should be tackled in two parts: the main breaker or fuse box and the circuits. If the main box got wet, it should be checked and cleaned by an electrician before you turn the power back on. You should have the electrician move your main box above flood level for future protection.

Meanwhile, *if you are comfortable working with electrical fixtures and wiring*, you can clean the flooded circuits. Otherwise call an electrician.

To clean a flooded circuit, follow these steps in order:

1. *Check the switch at the main breaker or fuse box to make sure that the power is still off.* Take out the fuses or switch off the breakers to the circuits you will be working on.
2. As noted at the end of Step 2, everything should be unplugged and all light bulbs should be removed. The switches and outlets should be out of the wall. Check the switches and outlets and their boxes for mud and dirt which can cause a short or overheating. Hose or wash any mud out of the boxes.
3. If you see a lot of mud, dirt, or salt water corrosion in the switches or outlets, replace them. If you want to keep the switches and outlets that were

flooded, rinse them thoroughly in a pail of water. Let them dry for at least 24 hours.

4. Check the condition of the wire that goes to each switch and each outlet. Replace any fabric-covered wire. Plastic covered wire does not need to be removed unless it has been flooded with salt water. Aluminum wiring may be severely corroded by salt water, so all aluminum wiring that has been flooded by salt water should be replaced before proceeding.
5. After everything has dried out, check to make sure the fuses are still out or the breakers are still switched off. Then re-install the switches and outlets or install new ones.

If your main box was not flooded or if it has been cleaned and checked by an electrician, you can test each circuit once it is cleaned.

To test a cleaned circuit:

1. Make sure nothing is plugged in and no wall switches are turned on.
2. Install the fuse or turn the breaker to "ON." Install the main fuse or turn on the main breaker. Some fuse boxes have a main switch—a handle on the outside of the box that is easier to use than taking out and replacing the main fuses.
3. If the fuse blows or the breaker clicks back to "off," you have a short somewhere. Recheck your cleaning and installation work. If the fuse or breaker are okay, wait 15 minutes and then walk around the home. Look

Electrical Safety

- Use only the electrically operated tools you need, one at a time, to avoid overloading a few working circuits.
- If appliances or motors have gotten wet, have them taken apart, cleaned, and dried. before plugging them back in again.
- Make sure all appliances are properly grounded. This is most important if there was damage to the wiring from the flood or during the cleaning.
- Mud or dirt in a grounded outlet or adapter may prevent the grounding system from working, and you could be electrocuted. If you are unsure of whether your electrical system is properly grounded, call an electrician.
- When in doubt, call an electrician. Electrocution is a major killer in floods.

Important

It is very important that your utility systems and appliances be turned back on the correct way. A leaky gas pipe, an ungrounded electrical appliance, or contaminated water is a serious safety and health hazard. **If you are not comfortable working on your utilities or appliances, call a professional.**

for sparks or the pungent smell of an electrical short. If there are any signs of smoking or heating, if the fuse blows, or if a breaker goes off, turn the power off and call an electrician.

4. If there are no signs of problems, turn the power off again. Plug a lamp or small appliance in an outlet on the circuit you just tested, or turn on a light switch. Be sure that the appliance you are using to test each outlet is working properly.
5. Turn the power back on and check the fuse or breaker.
6. Repeat steps 4 and 5 for each outlet and wall switch to check for shorts or problems.
7. Bathroom and outdoor circuits often have a ground fault circuit interrupter at the breaker box or at a wall outlet. These are very sensitive and may keep tripping the circuit off, so you may have to be extremely thorough in cleaning and drying these circuits.

Water supply

Public water suppliers usually provide water soon after the flood. If you are unsure of your water supply, only use it to hose your home or for sanitation purposes (flushing the toilet).

Buy bottled water for drinking if you can. Sometimes large water storage tanks called “water buffalos” are brought to communities that need clean water. They are filled with clean drinking water from places outside your area and are towed to your location, often by national guard or U.S. military personnel.

A “boil order” may be issued in your community. If such an order has been issued, do the following:

1. Fill a large pot with water from the tap.
2. Strain the water through cheesecloth, a sheet, or other clean, porous material to remove as many solids as you can.
3. Bring the water to a rumbling boil and let it boil for at least 5 minutes.
4. Pour the water back and forth between two clean pots. This will help it cool and will also add air to the water to make it taste better.
5. Let the water cool. After it is cool, add 16 drops of liquid chlorine bleach per gallon of water. Let the water stand a half hour. If it gives off a slight chlorine smell and looks clear, it’s OK to use.

If you do not smell the chlorine or if the water is still cloudy, add another 16 drops of liquid chlorine bleach and let it stand another half hour. If you smell chlorine, it’s okay to use. If you have treated it again and it still does not smell like chlorine, don’t use it for drinking or cooking.

Do not cook in pots and pans, or use eating utensils, baby blankets, or any other items that could go in the mouth until they have been washed in water that has been tested and approved by the water supplier or health department.

Wells. Private wells should be pumped until the water is clear. You can decide whether water is clear enough to hose the home and do other cleaning work. Check with the local health department for instructions before you drink or cook with your well water. Their instructions will account for minerals and chemicals that occur naturally in your area. The health department should be able to advise you about the best way to have your water tested if necessary.

If there are no specific instructions from the local health department, follow these steps to treat your well and water:

1. Open your faucets to pump the water out of your well. Let them run for at least 15 minutes or until you lose pressure.
2. Pour one quart of liquid chlorine bleach in the well and leave it for at least four hours. Do not use any water during this time.
3. Open all the faucets and let them run until you smell chlorine at each faucet.
4. Turn off the faucets and let the water sit in the pipes for two to four hours. Do not use any water during this time.
5. Flush out the system by running the taps until you can no longer taste or smell the chlorine.

Water Heater. Check your water heater. If floodwaters got into the gas burner, electrical parts, or insulation, it should be replaced. If you want to save it, have it cleaned and restarted by a professional. Be sure to flush clean water through it before you wash dishes or clothes with hot water.

Sewage disposal

Public sewers should work soon after a flood, but mud and debris might clog them. Flush the toilet before you use it. If it is clogged, check with your local sewer department to see if the problem is in the main line. You may need to clean out the sewer line from your house to the main line.

Septic systems will not work until the ground water level is below the distribution lines. So be careful about flushing the toilet and pouring things down the drain; they may not have anywhere to go. Until your toilet works, you can line it with a plastic trash can liner and dispose of the bag following local public health recommendations.

**Cleanup and Repair—
Who does what?**

If your house will be unheated for a few days, and the temperature will fall below freezing, you should winterize your water pipes so they will not freeze and break. A plumber can blow out the pipes to make sure they are empty. Or you can take the following steps to protect your water and sewer system from damage due to freezing temperatures:

1. Shut off the main water valve. (It is usually found at the water meter.)
2. Turn on all the faucets in the house, both the hot and the cold taps. Leave them on and let them run.
3. Turn off the hot water heater. Open the faucet at the bottom of the water heater to drain it. You may want to connect a hose to the faucet so you can control where the water goes. Be careful; the water may be very hot.
4. Flush the toilets to empty their water tanks.
5. Wait for the lowest faucet on the house to stop running. (This will usually be a faucet in the basement.) Then check all faucets and toilets. If they have stopped running or are empty, your water system should be drained.
6. Pour some propyleneglycol-based antifreeze in all sink, tub, and floor drains and in the toilet bowls. (This type of antifreeze is available through recreational vehicle and mobile home dealers. **Do not use regular automotive antifreeze.**) These drains have traps that keep water in them.
7. You can turn the main valve back on after the building is heated. Do this before you start your repairs. That way, if there is a broken pipe, a water leak won't cause much damage.

6 **STEP** Clean Up

The walls, floors, closets, shelves, contents—every flooded part of your house—should be thoroughly washed and disinfected. Some projects, such as washing clothes, may have to wait until all the utilities are restored. Others may be best done by professionals. This section offers suggestions on the best way to clean flooded items.

Cleaning Supplies Checklist

- Brooms, mops, brushes, sponges
- Buckets, hose
- Rubber gloves
- Rags
- Cleaner
- Disinfectants
- Lubricating oil
- Trash bags
- Hair dryer

Clean up supplies

The Red Cross will often distribute cleanup kits after a disaster. These contain many useful items such as a broom, mop, bucket, and cleaning supplies.

In most cases, household cleaning products will do the job if you use them correctly. Check the label on the products to see how much to use. Some products shouldn't be used on certain materials; the label will tell you that. Apply cleaner and give it time to work before you mop or sponge it up. Follow directions and all safety precautions on the container.

After cleaning a room or item, go over it again with a disinfectant to kill the germs and smell left by the floodwaters. You may also need to get rid of mildew, an unwelcome companion to moisture that shows as fuzzy splotches.

Cleaning tips

Tackle one room at a time. A two bucket approach is most efficient: use one bucket for rinse water and the other for the cleaner. Rinse out your sponge, mop, or cleaning

cloth in the rinse bucket. Wring it as dry as possible and keep it rolled up tight as you put it in the cleaner bucket. Let it unroll to absorb the cleaner. Using two buckets keeps most of the dirty rinse water out of your cleaning solution. Replace the rinse water frequently.

Walls

Start cleaning a wall at the bottom or where the worst damage was. If you did not have to remove the wallboard or plaster, you may find it the wallboard or plaster won't come clean and you will want to replace it rather than clean it. If you have removed the wallboard or plaster, wash the studs and sills and disinfect them.

Windows

If you taped your windows before the storm, clean the tape off as soon as possible. The sun will bake the adhesive into the glass. If glass cleaners don't remove the adhesive, try tar remover, acetone, nail polish remover, or a razor blade. And next time, don't bother taping the windows. You don't get much protection for all that effort.

Furniture

Don't try to force open swollen wooden doors and drawers. Take off the back of the piece of furniture to let the air circulate. You will probably be able to open the drawers after they dry.

Solid wood furniture can usually be repaired and cleaned, but wood veneer often separates and warps. Wood alcohol or turpentine applied with a cotton ball may remove white mildew spots on wood. Cream wood restorers with lanolin will help restore good wooden furniture parts.

Upholstered furniture soaks up contaminants from floodwaters and should be cleaned only by a professional. This is also true of carpets and bedding. Unless the piece is an antique or especially valuable, upholstered furniture soaked by floodwaters should probably be thrown out. Get a cost estimate from a professional to see if furniture is worth saving.

Appliances

There's an unexpected danger of shock with some electrical appliances such as TV sets and radios. Certain internal parts store electricity even when the appliance is unplugged. Check the back for a warning label. Appliances with such labels will need professional cleaning. But first, get a cost estimate to see if they are worth saving.

You'll need appliances such as the washing machine, dryer, dishwasher, and vacuum cleaner to help clean your home and contents. The motors or heating elements can usually be cleaned. If you can't wait for a professional cleaning job, unplug, disassemble, and hose off the appliances thoroughly (with hot water, if possible). Then clean and disinfect them, but do not use detergents.

Clean and disinfect dishwashers, washing machines, and dryers

only with water that has been declared safe for drinking. Make sure the sewer line is working before starting a dishwasher or washing machine.

You can speed up the drying process for motors and parts by using a blow dryer using a moisture displacement spray. Moisture displacement sprays, such as electronics parts cleaners or WD-40 lubricating and penetrating oil, are available at hardware or automotive parts stores. The sprays can also stop rust and corrosion until the appliance can be disassembled and cleaned. One word of caution: the spray is flammable. Read and follow label instructions and precautions.

Moving parts such as motors and pulleys will need oil or grease. Contacts and electrical switches can be cleaned with a moisture displacement spray or an aerosol contact cleaner available at electronics or auto parts stores. Allow a motor to run for 30 minutes with no load before you use it. For example, run the vacuum cleaner without connecting the belt.

Watch for stripped or damaged wire insulation. Be sure all appliances are properly grounded. This is most important if there was damage to the wiring from the flood or during cleaning. Appliances that must be grounded have a round third prong on their plugs. Review the information on your electrical system in Step 5.

Refrigerators and freezers are more complicated. They may have foam insulation and sealed components that suffered little water damage. But those appliances hold food, so they should be

Cleaners

1st choice: Non-sudsing household cleaners

2nd choice: Laundry soap or detergent

Disinfectants

1st choice: Commercial disinfectants or sanitizers, such as the quaternary, phenolic, or pine oil based ones. (Check labels for the contents).

2nd choice: 1/4 cup (2 ounces) of laundry bleach for 1 gallon of water.

Mildew Removers

1st choice: Commercial mildew removers or mildewicides

2nd choice: Washing soda or tri-sodium phosphate (available at grocery or paint stores). Use 5 tablespoons per gallon of water.

3rd choice: 1/4 cup (2 ounces) of laundry bleach for 1 gallon of water. See below on using bleach.

Bleach

Liquid chlorine bleach, such as Clorox or Purex bleach, can do a variety of flood clean up jobs. Make sure that 5.25% sodium hypochlorite is the only active ingredient. Bleach that has a scent added to improve its smell is available. Scented bleach is fine for cleanup jobs, but don't use it to treat drinking water. Don't use dry bleach or any bleach that does not contain chlorine.

Be careful of fumes and wear rubber gloves. Read the safety instructions on the label. Do not mix bleach with other household chemical products, especially ammonia or toilet bowl cleaner; the chemical reaction can create a poisonous gas. Do not use bleach on aluminum or linoleum.

cleaned, disinfected, and checked by a professional, or replaced. If your repair person says an expensive appliance should be replaced, get the opinion in writing and discuss it with your insurance adjuster before you spend money for another one.

Clothing and Linens

Even if your washing machine did not get wet, do not use it until you know that the water is safe enough to drink and that your sewer line works. (Perhaps a friend or relative has a washing machine you can use until yours is clean and working.)

Before you wash clothes in the washing machine, run the machine through one full cycle. Be sure to use hot water and a disinfectant or sanitizer.

Take clothes and linens outdoors and shake out dried mud or dirt before you wash them. Hose off muddy items to remove all dirt before you put them in the washer. That way your drain won't clog.

Check the labels on clothes and linens, and wash them in detergent and warm water if possible. Adding chlorine bleach to the wash cycle will remove most mildew and will sanitize the clothing, but bleach fades some fabrics and damages other fabrics. You can buy other sanitizers, such as pine oil cleaners, at the grocery store to sanitize fabrics that cannot be bleached.

If the label says "Dry Clean Only," shake out loose dirt and take the item to a professional cleaner. Furs and leather items are usually worth the cost of profes-

sional cleaning. If you want to clean leather yourself, wash the mud off and dry the leather slowly away from heat or sunlight.

Kitchen items

Throw out soft plastic and porous items that probably absorbed whatever the floodwaters carried in. Floodwaters are contaminated, so you may want to wash dishes by hand in a disinfectant. Air dry the disinfected dishes; do not use a dish towel.

Like the washing machine, the dishwasher should also be used only after you know your water is safe to drink and your sewer line works. Clean and disinfect it first. Then use a hot setting to wash your pots, pans, dishes, and utensils. (If you have an energy saving setting, do not use it.)

Food

Throw any food out that has been touched by floodwaters. Even food in tin cans should be discarded if the cans got wet during the flood because there is no way to be absolutely certain the food inside is safe. Do not keep food in bottles or jars with bottle caps or screw on lids—they do not keep out floodwaters.

The U.S. Department of Agriculture operates a food safety hotline. Professional home economists can answer your questions about whether to keep or discard food. Call 1-800-535-4555 between 10:00 am and 4:00 pm, Eastern Time, Monday through Friday.

Paper and books

Valuable papers such as books, photographs, and stamp collec-

tions can be restored with a great deal of effort. They can be rinsed and frozen (in a frost-free freezer or commercial meat locker) until you have time to work on them. A slightly less effective alternative to preserving an item is to place items in a sealed container, such as a plastic bag, with moth crystals.

Papers should be dried quickly when they are thawed or unsealed (a blow dryer will do). Don't try to force paper products apart, just keep drying them. Photocopy valuable papers and records soon because substances in the water may make them deteriorate.

If a computer disk or tape has valuable information, rinse it in clear water and put it in a plastic bag in the refrigerator. Later, you can take it to a professional drying center and have the data transferred to a good disk or tape. Many companies that specialize in restoring computers and computer records after a disaster are members of the Disaster Recovery Institute. To find a member company near you, you can call the Institute at (314) 846-2007.

The Yard

As you get rid of things from your home, don't turn your yard into a dump. Food and garbage must be hauled away as soon as possible. Other discarded items should be removed as soon as your insurance adjuster has told you how to make sure their loss is covered. Other things you throw away should be removed as soon as your insurance adjuster says it's okay.

Mosquitoes can carry many diseases, and a flood can create ideal conditions for them to breed.

Drain or remove standing water that can become a breeding ground. Dump water out of barrels, old tires, and cans. Check that your gutters are clean and can drain. Ditches and drains also need to be cleaned so they can carry stormwater away from your home.

If you can't get rid of standing water, use a commercial product that kills mosquito larvae but does not harm other animals. A slightly less effective method is to apply a thin film of cooking oil on the water. Repeat the application within a few days after a rain has disturbed the film.

The Lawn

Lawns usually survive being underwater for up to four days. Salt water should be hosed off the lawn and shrubs. Some grasses are not damaged by saltwater flooding. Check with your local nursery, garden store, or Cooperative Extension Service. You may have to replace the lawn if there was mud thicker than one inch deep, erosion, or chemicals in the floodwaters.

Further Information

You will probably see more detailed instructions on how to clean various contents in your local paper or hear them on the radio or TV. Many Cooperative Extension Service offices have more information, especially on animals, vegetables, landscape plants, and household items. Check your telephone book under the name of your county. For example, if you live in Montgomery County, look under Montgomery County Cooperative Extension Service.

7
STEP*Check on Financial Assistance*

How much you rebuild and replace depends on what you can afford. Four sources of financial assistance can help you through recovery: insurance, government disaster programs, voluntary agencies, and businesses. If you are fully insured (80 percent of the replacement cost of your home), you may only have to pay the deductible and your flood insurance policy will pay for professional cleaning and reconstruction. Even if you are insured, the other sources of assistance can help with expenses that your insurance policy doesn't cover.

Voluntary Agencies

Private voluntary agencies such as the American Red Cross, Salvation Army, and church groups are usually on the scene during or right after a flood. These groups usually provide for immediate needs such as clothing, groceries, shelter, medical aid, and counseling.

Some private organizations can help you restore your home. They may offer supplies or sometimes volunteers to help you clean up and rebuild. The services are usually provided free of charge regardless of a person's eligibility for government aid. The services are usually provided free of charge regardless of a person's eligibility for government aid.

The American Red Cross provides emergency assistance to people affected by disasters, whether or not the affect area has

been declared a disaster area by a governor or the President. All Red Cross disaster assistance is free and is provided as a gift of the American people. The Red Cross does not receive funding from the government to provide this assistance.

The American Red Cross can help by providing you with a voucher to purchase new clothing, groceries, essential medications, rent, bedding, essential furnishings, and other items to meet emergency needs. The Red Cross can also provide you with a cleanup kit: mop, broom, bucket, and cleaning supplies. Listen to news reports to find out where to go for this assistance, or look up American Red Cross in the telephone book and call. You can also find your local Red Cross chapter by doing a search through the Red Cross site on the Internet's Wide World Web at <http://www.red-cross.org>.

Businesses

Your local TV, radio and newspapers will usually publicize how businesses are contributing to the recovery process. Some businesses may offer reduced prices, but be wary of "flood sales" that are selling flood damaged items.

Some insurance companies and lenders may let you delay your monthly payments. Sometimes banks will make lower interest loans available for reconstruction. While these may seem easier to

obtain than government disaster loans, their interest rates are usually higher.

Be careful about out-of-towners offering “special deals,” especially repair contractors. Sometimes the local builders’ association will offer advice on reconstruction or advice on choosing contractors. (See Step 8 on dealing with repair contractors.)

Flood Insurance Claims

You may have as many as three separate insurance policies: homeowner’s, flood, and wind and hail. This section covers the procedures for handling a flood insurance claim. Claims for non-flood damage will be handled in a similar manner.

You should call your flood insurance agent to report your damage as soon as possible after the flood. Your agent will arrange for an adjuster to visit your home so that your claim can be settled. Be sure you leave phone numbers where you can be reached.

If you are unable to contact the local agent, call the National Flood Insurance Program at 1-800-638-6620.

Under ideal conditions, the adjuster should contact you to set up an appointment to visit your home within a few days after you call your agent. But if flood damage is widespread in your area, it may take longer for the adjuster to visit, and it may take time for your claim to be settled. If flooding is extensive, the adjusters will schedule their visits to review the most severe damage first. The adjuster cannot estimate your damage until floodwaters are away from the building.

In the meantime, protect your home and its contents from additional damage, but do not make repairs that make it impossible for the adjuster to see the damage. Step 2, “Give Your Home First Aid,” discusses how to protect your home from further damage.

While you are waiting for the adjuster, the following suggestions will help you organize the information that you will need:

- Take photos or videotape the damage** to both the inside and outside of the building and the contents.
- Separate your damaged and undamaged belongings** and store them for the adjuster to examine.
- Find receipts, canceled checks, or proofs of purchase** for high cost items such as major appliances, if possible. The adjuster will need the manufacturer’s name; serial and model numbers; price; location and date of purchase; and a description of the items.

The claims adjuster’s job is to collect information that is sent to a central office for processing. The insured (you) must file a Proof of Loss form within 60 days of the flooding. In most cases, the adjuster will file this form for you. The form states the amount of your loss and is signed by both the insured and the adjuster. An important point to remember is that *you will not be reimbursed for expenses not authorized by the adjuster.*

You can ask the adjuster for an advance or partial payment for your building or contents loss,

Some Points on Settling Claims

- You are supposed to be reimbursed fairly for your loss, but you are not supposed to profit from a disaster.
- You cannot collect more than the face value of your policy.
- You cannot collect for uninsured items, such as landscaping.
- Most adjusters receive a flat salary or compensation on a per case basis. There are no financial incentives that encourage the adjuster to give you a small claim payment.
- You should get the adjuster’s name, company, and phone number. He or she will probably be from out of town.
- In most cases, you will be reimbursed for the actual cash value of an item. That is the cost of replacing the item minus depreciation. If your policy is for 80 percent or more of the replacement cost of your house, you will be reimbursed for the replacement value of damage to your house (no depreciation).
- If you have problems with a flood insurance claim, your policy should list an office or telephone number that you can contact or you can call your insurance agent.

DAC Visit Checklist

Before you got to a DAC or phone the toll-free number, do your best to get together the following information and documents. If you don't have all of them, don't worry; gather what you have and start your disaster assistance application process.

- Your name, address, Social Security number, and identification
- Telephone numbers where you or a neighbor can be reached
- Names and ages of all persons living in your home at the time of the flood
- Insurance papers, including the "Proof of Loss" form
- A summary of your damage and a rough idea of the cost of repair or replacement (See Step 3.)
- Your income and the income of all other members of your household.
- Who you owe money to and how much you owe (mortgage, car loan, etc.)
- The total amount of your living expenses (rent, mortgage, food, clothing, utilities, medical, and transportation costs)
- Directions to your property, starting from a major road, and a road map with an X for your property.

especially if you need the money to make your home liveable. An advance will not affect the total amount of your payment. Later, when your total payment is determined, the amount you were advanced will be subtracted from it. You can also ask for a partial payment if you disagree with the amount of your loss on the Proof of Loss form. Tell your adjuster if you disagree and ask what steps can be taken to straighten out your claim payment.

The check to settle your flood insurance building claim will most likely be in your name as well as the name of your mortgage holder. Some insurance companies may send the payment to your mortgage holder. Talk to your mortgage company ahead of time to make sure there won't be a delay in getting your claim payment to you.

Disaster assistance

If the flooding was widespread and caused a lot of damage, your community might be eligible for state or federal aid. To receive such assistance, your community must be declared a disaster area by your Governor, a federal agency director, or the President. Local newspaper, radio and TV will keep you informed about disaster declarations and where to get information about any programs that might be available to you.

If the flood were severe enough for your area to be declared a disaster area by the federal government, the Federal Emergency Management Agency may open "teleregistration", which provides a

toll-free number for you to call to request assistance. Or, it may open one or more Disaster Application Centers (DAC). These centers will give information and take applications for assistance and are usually located in a nearby school or other public building. They will be open during the day and early evening for several days to give people time to come in. Check local newspapers, TV and radio reports for the location and hours.

Federal disaster assistance may be available in some cases to deal with uninsured losses and needs. People who are not insured should go to a DAC first. If possible, those with insurance should file their Proof of Loss form before visiting a DAC. If there is a long wait, you can make an appointment for a later day, or use the toll-free number. (Look at FEMA's site on the World Wide Web for more information: <http://www.fema.gov>).

When you go to a DAC or apply for disaster assistance, take the items listed below: The first person you will talk to at a DAC will be a receptionist. He or she will review your damage and needs, and identify which programs are most appropriate for you. You will receive a checklist of programs that can help you. You can then talk to representatives of these programs at tables in the DAC.

There are six types of federal or state disaster assistance. Except as noted, the following are available only if the President issues a disaster declaration for your area.

Disaster Housing Assistance

This program may provide a safe place to live until repairs to damaged homes are completed. Rent assistance or mobile homes may be provided to those without insurance. If repairs can be done quickly to make your house livable, the program may provide funds to make those repairs.

Disaster Loans

Home and business owners, farmers, and others with real or personal property losses may be eligible for low interest loans. These loans are administered by the federal government's Small Business Administration (SBA) and the Farmers Home Administration (FmHA). SBA and FmHA can provide loans even if there is no Presidential disaster declaration.

Eligibility and loan interest rates vary according to the income and financial condition of the applicant. Check your local paper or TV or radio station for the type of loans available for replacing your personal property and for repairing your house.

Individual and family grants

This program may provide funds for necessary expenses and serious needs. Grants can cover immediate expenses such as medical treatment, transportation, home repair, replacement of essential personal items, and the cost of protecting your property from the flood. Applicants must not have other financial resources or be able to qualify for an SBA disaster loan.

Income tax deductions

If a federal disaster declaration was made, you might qualify to file an amended tax return for the past year and get a partial refund for your uninsured casualty losses. Even if no federal declaration is made, you can often deduct your uninsured losses on your next income tax return. Ask the Internal Revenue Service for Publication 547, *Non-Business Disasters, Casualties, and Theft* to get more information.

Floodproofing assistance

Restoring a building to its pre-flood condition used to be the focus of government disaster programs. Now, some programs encourage "floodproofing,"—that is, modifying the structure to help it withstand damage from the next flood. (See Step 8.) The SBA's Disaster Loan program can loan additional money to cover certain floodproofing costs—ask SBA about it. Other programs will vary from state to state.

Counseling

A variety of programs give advice on recovering from a disaster. These include help with unemployment, food stamps, income taxes, insurance claims, legal issues, veterans benefits, and crisis counseling. Crisis counseling can be especially helpful in coping with problems as you recover from the flood before they get out of hand. Be sure to ask the Red Cross about "Disaster Mental Health" information.

STEP

Rebuild and Floodproof

Don't just build it back; build it better. Now is the best possible time to think about floodproofing your home because you can take definite action to protect your property in the future. Many floodproofing measures are quite simple, cost effective, and easy to put in place. By floodproofing as you rebuild, you can make the next flood easier on you and your wallet.

Floodproofing

Floodproofing means to remodel or rebuild using materials and methods that will prevent or minimize damage from future floods. Consider the benefits to floodproofing your home:

- By protecting your home from damage, floodproofing will save you money and aggravation during the next flood.
- Many floodproofing measures are inexpensive.
- Protecting your house from future flood damage will increase your property's resale value.
- Many floodproofing measures can be easily worked in during repair and rebuilding, reducing your costs.
- Some financial assistance programs can help pay for floodproofing.
- By preparing for the next flood, you regain control over your future—a guaranteed way to reduce your level of anxiety and stress. You don't have to wait

for the government to act; you can take care of protecting your home when you are ready.

- Floodproofing won't make it possible for you to stay at home in a flood. But it is likely to make it much quicker and easier for you to clean up the next time.

Before you repair or rebuild, the first thing you should do is talk to your town's or city's or county's building department. You will need to ask the following questions:

- What are the procedures for applying for a building permit? What inspections will need to be done?
- Is your home substantially damaged? (Substantially damaged means that the cost to restore your home to its "before damaged" condition would equal or exceed 50% of the market value your home had before the damage occurred.) *The flood protection level* is the level of flooding that you want your house to be able to withstand without damage to your house or your belongings.

Start by asking your building department what flood protection level it requires for your area. If there has been a flood higher than the level they give you, you should use that flood's level plus 1 or 2 feet for safety. The next flood may be worse.

The next step is to decide if you will be better off living in a different location, away from areas that flood. Ask your building official about government agencies that sometimes purchase property for open space or flood protection in areas that flood—you may qualify.

If you are sure that you will repair or rebuild your house in the flood-prone area, choose the floodproofing type that is best for your home or property. There are five basic types of floodproofing described here, as well as rebuilding tips to help you safely repair and rebuild.

Five Types of Floodproofing

1. Elevation

Most buildings can be raised so that the lowest floor is above the possible flood level. If you had foundation damage from the flood, you may need to raise the house to repair it. It will be easier and cheaper to elevate the house at that time.

There should be many contractors qualified to undertake elevating your house above flood level. Elevation or relocation are the only reasonable ways to protect your home if it is subject to coastal flooding or to deep flooding (more than six feet deep.)



Elevation and relocation are also the most dependable measures for floodproofing your home.

An elevated building will need a new foundation. The contractor will jack up a structure and temporarily set it on a temporary framework called cribbing while the foundation is built underneath. The foundations of an elevated building may be columns, piers, pilings, or raised foundation walls. The elevated building will usually look better and have added protection if fill dirt is placed around the new foundation. But check with your building department before adding fill dirt. It may not be allowed in your community.

2. Relocation

Moving a building out of the flood-prone area is the surest way to protect it from flood damage. Most houses and smaller commercial buildings in good condition can be moved, and it is usually no problem to find contractors experienced in moving buildings. You will have to purchase a new lot unless your present lot is large and has a good spot on higher ground for your house. Relocation and elevation are the only reasonable choices for protecting a home that is subject to deep flooding (of more than six feet in depth) or to coastal flooding.

3. Floodwalls

Floodwalls, berms, and levees all work to keep floodwaters from reaching your house. They are built to at least the height of the flood protection level in your area. Floodwalls are usually made of



concrete. Berms are simply small levees, usually built from fill dirt.

Floodwalls, berms, and levees can either surround the building (ring levee) or connect to high ground. They can also be built up against a building's foundation walls. a sump and pump will be needed to pump out water that seeps under the wall. Floodwalls, levees, or berms may not be allowed in your area if they could create a drainage problem on your neighbor's property. check with your building department before you build.

Floodwalls of all types work best in places where flooding is less than three feet deep. If floodwaters near your home develop swift currents, floodwalls, levees, and berms cannot be used—they may wash away. floodwalls and berms may not be appropriate for homes with basements.

If there is not enough room for a berm or levee, you may be able to build a floodwall made of concrete, which takes up less room. The walls should contain internal reinforcing bars to give added strength as well as to help walls resist cracking and settling over time. Walls must be properly anchored to withstand the same water pressure that can destroy basement walls.

4. Dry floodproofing

Dry floodproofing means sealing a building to keep floodwaters out. All areas below the flood protection level are made watertight. Walls are coated with plastic or rubberized sheeting or special waterproofing compounds. Openings such as doors, windows, sewer lines, and vents are closed permanently, or can be temporarily sealed with removable shields or sandbags.

Dry floodproofing can only be done if the walls of your home are strong enough to hold back the floodwaters without collapsing. For this reason, dry floodproofing is not recommended if floodwaters are expected to be more than two or three feet above the ground level. Dry floodproofing is generally *not* appropriate for houses with basements or crawl spaces.

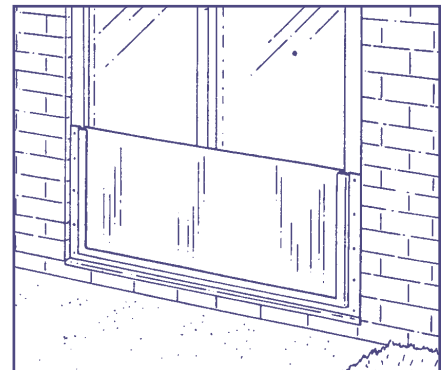

5. Wet floodproofing

Wet floodproofing means modifying a building so that floodwaters will cause only minimal damage to the building and contents. Building materials below the flood protection level are replaced with materials that are resistant to water. Floodwaters are allowed into the building to counteract the pressure of the water on the outside of the walls.

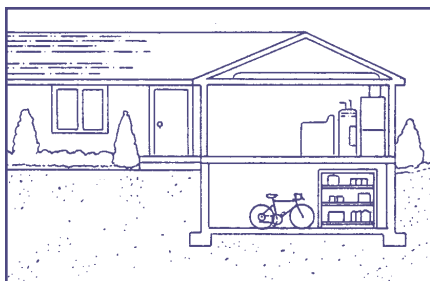

You should furnish areas that have been wet floodproofed with light, portable furniture that can be easily and quickly moved before a flood. Objects that are difficult to move, such as furnaces, water heaters, appliances, and bookcases, are either put on platforms or reinstalled upstairs.

Wet floodproofing has one advantage over the other four floodproofing types: even the smallest efforts will significantly reduce flood damage the next time. Thousands of dollars can be saved simply by moving furniture and electrical appliances out of areas that will flood. If you decide not to use one of the other four floodproofing types, you should use wet floodproofing measures as you repair and rebuild. The rebuilding tips in this section give more wet floodproofing ideas.

Building permit

Once you've determined the repairs and floodproofing measures you are going to take, local codes generally require that you get a building permit. Before you make repairs or alterations to your home or property, make sure your plans are reviewed and okayed by your building department. You may also need to get the okay of our homeowner's association or mortgage holder before you make

repairs or alterations to your home or property.

If you are just replacing items such as carpeting or wallboard, you will probably not need a permit—but you should check with your local building department before you proceed. You will usually have to get a permit for electrical work and repairs of structural damage, such as broken walls.

Most local and state building codes require that a building that is substantially damaged be treated as a new building. A new residential building must be built so that its lowest floor is at or above the flood protection level. In other words, if your home meets the criteria described above for “substantially damaged,” you will have no choice but to elevate or relocate your home in order to meet local building codes.

Failure to follow the local building code can result in an order to stop reconstruction, a fine, imprisonment, higher flood insurance rates, denial of flood insurance, or all of the above.

Rebuilding tips

Give your house plenty of time to dry. Many problems result from rebuilding after a flood before everything dries. If it takes a week for the visible signs of moisture to disappear, allow at least another week for the parts you cannot see to dry. Don't try to force a swollen door to close. Don't force wooden parts to fit. When completely dry, the wood may regain its original shape.

There are small, inexpensive measures you can take to make your recovery easier after the next flood.

Products that resist water damage

- Concrete, concrete block, or glazed brick
- Clay, concrete, or ceramic tile
- Galvanized or stainless steel nails, hurricane clips, and connectors (in areas subject to salt water flooding)
- Indoor-outdoor carpeting with synthetic backing (do not fasten down)
- Vinyl, terrazzo, rubber, or vinyl floor covering with waterproof adhesives
- Metal doors and window frames
- Polyester-epoxy paint (do not use mildew-resistant paint indoors, especially on cribs, playpens, or toys because it contains an ingredient that is toxic.)
- Stone, slate, or cast stone (with waterproof mortar)
- Styrofoam insulation
- Water resistant glue

Utilities

Move the main breaker or fuse box and the utility meters above the flood protection level for your home. Make sure each circuit is labeled so you know which circuits control which outlets and fixtures. If the electrical code allows, raise the electrical outlets and switches above your flood protection level.

If you are going to replace a flooded furnace, water heater, or air conditioner, install the new one on a higher floor. If your new air conditioner or heat pump will be outside, install it on a platform above the flood protection level. A water heater can be put anywhere near a hot water pipe. An updraft furnace located in a basement can be replaced with a downdraft furnace on a floor above the flood protection level.

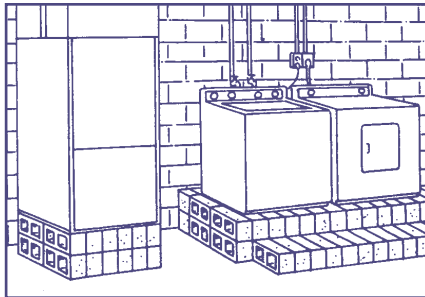

Where the flood protection level is not too high, a furnace, water heater or other heavy appliance can also be raised on a platform inside the house. Put the appliance on concrete blocks or a wooden platform supported by concrete blocks. Make certain that appliances such as washers and dryers are secure and will not vibrate off the blocks or platform during use.

You can protect the furnace, water heater, washer, and dryer from shallow flooding with a low floodwall built around the appliance. A concrete or wooden wall 1 or 2 feet high can stop low-level flooding. The wall should be waterproofed with plastic sheeting or waterproofing compounds that can be purchased at hardware stores.

Walls

Wash and disinfect the studs and sills if the wallboard and insulation had to be removed. If you are going to rebuild the walls, remember that metal studs and sills are not damaged by water as much as wooden ones.

Pressure-treated wood will resist mildew and wood eating insects outdoors, but it may swell as much as untreated wood when soaked. Some kinds of pressure-treated wood should not be used inside the house, where they will come into contact with food or skin. (It depends on which chemicals were used to treat them.) Ask your lumber company to help you choose the right products for jobs you will do. They would also have consumer information sheets that give specific precautions for some products. Ask for them.

Wallboard

Think horizontal rather than vertical. Install the wallboard panels sideways so they are only four feet high. If the next flood is less than four feet deep, you only have to replace half the wall.

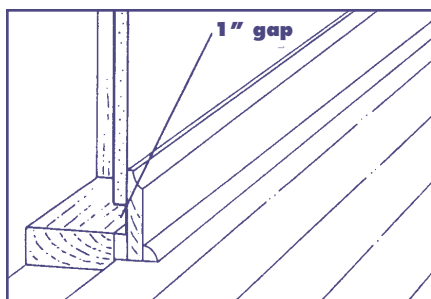

This drawing shows another suggestion. Leave the wall open one inch above the sill. The baseboard will hide this gap. When you remove the baseboard after the next flood, the wall cavity will drain freely and air will circulate better. Check your local codes, however. If a firewall is required, the building code may not allow the gap.

“Greenboard” or other moisture resistant wallboard is made for bathrooms and other damp areas, such as basements. It may be more sturdy when wet than regular wallboard. However, if soaked with floodwaters, it will present the same health hazard as regular wallboard and should be replaced.

Floors

Some floors are made with particle board or plywood, materials that fall apart when wet for long. Floor joists and some wood floors will regain their shapes if allowed to dry naturally.

After re-nailing, a wooden floor may need a little sanding to be smooth, or you can place a new underlayment for a new floor over it. Use screws or screw nails on floors and stairs to minimize warping. Do not lay new flooring or carpet until the subflooring is completely dry.

Painting

Do not paint until the surface is completely dry. If the surface still contains moisture, the paint will peel. Things look dry on the surface long before they are dry on the inside, and this can lead to costly mistakes. It may take several weeks for the surface to dry out enough.

To get an idea if a wall or floor is dry enough to paint, dry an area approximately 18 inches square with a blow dryer. (When checking a wall, select an area near the floor where it will be most damp.) Cover the area with a piece of clear plastic sheeting. Carefully seal all the edges with tape. Check the plastic 24 hours later. If there are beads of condensation on the side of the plastic that face the wall or the floor, it’s still too damp to paint.

You can cover concrete surfaces with a clear coating or penetrating sealer to make cleanup easier next time. Don’t paint over water stains—they will bleed through several coats of paint. Coat the stained area with shellac or a commercial stain killer before painting.

If you are going to dry floodproof your walls, don’t rely on waterproofing paints; they cannot keep floodwaters out. Such paints may protect a deck from rain, but they cannot protect walls and floors against the pressure of standing water. (Thick plastic or rubberized sheeting provides the most secure waterproofing seal.)

Products to Avoid

Avoid using or storing in areas likely to flood:

- Fiberglass or cellulose insulation
- Cork, corkboard
- Gasoline, weed killer, pesticide, lye, drain cleaner, swimming pool and other chemicals
- Linoleum
- Particle board, chipboard, fiberboard, paperboard, strawboard, Masonite paneling
- Wallboard, Sheetrock, drywall, gypsum
- Wallpaper

Windows

If you live near the coast, your home is likely to suffer damage from the high winds and floodwaters of a hurricane or nor'easter. Boarding up all your windows and doors are the best way to protect them from breaking and letting in the heavy rains that a coastal storm brings. Taping windows will not prevent them from breaking during a storm.

Cut plywood to fit each of your windows and doors well before a storm threatens. Label each piece so you'll know which window or door it covers. Store the plywood with the nails or other fasteners you will need to attach them. That way, you will be able to put the plywood up quickly when a storm threatens.

Contractors

You may need a contractor to help you rebuild, especially to handle the difficult jobs such as foundation repair and electrical work. If you have been satisfied with work done by licensed local contractors, try them first. If they cannot help you, ask them for recommendations.

If you must hire a contractor you do not know, talk to several contractors before you sign anything. Reputable contractors would agree that you should take the following steps:

- ☑ **Check on the firm's reputation.** The local Better Business Bureau, home builders association, or building trades council are excellent sources. Ask if the firm has had unanswered complaints filed against it.

- ☐ **Ask for proof of insurance.** Be sure the contractor has disability and worker's compensation insurance. If the contractor is not insured, you may be liable for accidents on your property.
- ☐ **Ask for references.** Contractors should be willing to provide names of previous customers. Call some of the customers and ask if they would hire the contractor again.
- ☐ **Ask for a written estimate.** Check it to make sure it includes everything you expect the contractor to do. Some contractors charge a fee for an estimate, which is understandable because they have plenty of work to do after a flood.
- ☐ **Ask for a contract.** The contract should be complete and clearly state all the work, the costs, and the payment schedule. Never sign a blank contract or one with blank spaces. If a lot of money is involved, it may be worth your while to have an attorney look at the contract before you sign it.
- ☐ **Ask for any guarantees in writing.** If the contractor provides guarantees, they should be written into the contract, clearly stating what is guaranteed, who is responsible for the guarantee (the dealer, the contractor, or the manufacturer), and how long the guarantee is valid.
- ☐ **Obtain a copy of the final signed contract.** Once signed, it is binding on both you and the contractor.

❑ **Don't sign off before the job is finished.** Don't sign completion papers or make the final payment until the work is completed to your satisfaction. A reputable contractor will not threaten you or pressure you to sign if the job is not finished properly.

Areas recuperating from floods are often prime targets for less-than-honest business activities. Building codes often require that work be done only by licensed contractors. Some building departments and trade associations keep lists of contractors who work in the community.

Here are some points to remember:

- Be cautious when contractors you don't know offer "special deals" after a disaster or want to use your home as a "model home."
 - Ask for complete financial details in writing and for an explanation of any differences from regular prices. Sales are worthwhile and they do exist, but be sure you are getting the services and products you are paying for.
 - Do not sign a contract when a salesperson has pressured you. Federal law requires a three-day "cooling off" period for unsolicited door-to-door sales of more than \$25. If you want to cancel such a contract within three business days of signing it, send your cancellation by registered mail. Other types of sales may have contracts with different cancellation clauses.
- Beware if you are asked to pay cash on the spot instead of a check made out to the contracting company. A reasonable down payment is up to 30% of the total cost of the project.
 - Make sure your contractor calls you or a qualified observer to inspect work before it is covered over. Shoddy work on sewers or basement walls will be hidden from view, and you won't know if there is a problem until the next flood. Most building departments will want to inspect electrical and plumbing lines before the walls are covered with wallboard or paneling.

If you are a victim of fraud or have problems with a less than reputable contractor, the state or local consumer protection office or public attorney should be able to tell you what to do.

S T E P

Prepare for the Next Flood

Be prepared is more than just a Scout motto. Your home will very likely be flooded again someday. Preparing for the next flood will protect you and your family, your property, your finances, and your peace of mind. In addition to the floodproofing measures discussed in the previous step, you should buy flood insurance, develop a flood response plan, and help your community implement a flood protection program.

Flood Insurance

Even if you have floodproofed your home, you still need insurance to protect you from the unexpected events such as a flood that rises higher than your flood protection level. If you have insurance, find out whether you have the right kinds of coverage, and whether you have adequate coverage. Homeowners' policies do not cover damage caused by floods, so you will probably need to purchase a separate policy under the National Flood Insurance Program (NFIP).

An NFIP policy covers:

- Damage to your building or contents caused by a general condition of surface water flooding (up to the amount of your coverage)
- Costs for protecting your property from flood damage, including moving and storing your contents for up to 45 days (up to the amount of the deductible)

- Expenses for removing debris left by the flood

An NFIP policy does not cover:

- Damage caused by high ground water, sewer backup, subsurface flows, or local drainage problems that are not considered a "general condition of flooding"
- Property located outside an insurable building, including fences, outdoor swimming pools, driveways, docks, floodwalls, crops in the field, and landscaping
- Vehicles, trailers on wheels, and boats
- Paneling, carpeting, furniture, and contents in the finished portion of a basement or underneath an elevated building
- Animals
- Money, valuable papers, and land values
- Living expenses and lost income

The NFIP provides federally-backed insurance coverage for any building in a community that is participating in the program. Almost every type of walled and roofed building can be insured.

It does not matter whether the building is in or out of the floodplain. A mobile (manufactured) home affixed to a permanent site and properly anchored can also be insured. You can get coverage on the building as well as for contents. **Building coverage.** Insurance can be purchased for

the walls, floors, insulation, wall to wall carpeting, furnace, and other items permanently attached to the structure. (Permanent items include anything that would not fall out if you turned the building upside down; i.e., items that stay with the building when it is sold.) Up to 10% of the policy value for building coverage may apply to a detached garage or carport on the same lot.

If you buy insurance for 80 percent or more of the replacement value of your home, you will be reimbursed for the replacement value of damage to your home—no depreciation will apply. If your coverage is for less than 80%, you will be reimbursed for the actual cash value of the damage—replacement value minus depreciation.

Contents coverage. Contents coverage insures your personal property. Renters as well as owners may purchase contents coverage. Although you can get contents coverage without having a building coverage policy, those contents must be located in a building that can be insured under the NFIP. Contents coverage will pay some costs to move and store contents in a safe place when a flood threatens.

Basements. Building coverage is recommended to cover the walls, floor, furnace, and other structural components of a basement. However, the NFIP does not cover finished portions of a basement (carpets, wallboard) or its contents. Damage to the basement foundation is a major problem during floods, so this coverage can be very important even though it does not cover the finished portions (carpets, wallpaper)

of basements. Some private companies sell coverage for water damage caused by sewer backup or sump pump failure—items that are not covered by the NFIP.

NFIP flood insurance is sold through private insurance agents and companies. All companies offer identical coverage and rates. Newer or substantially improved houses are charged according to their elevation in relation to the expected flood level. Older homes, which are “grandfathered” in, qualify for a flat, subsidized rate. Houses outside floodplains that are identified on Flood Insurance Rate Maps pay lower rates. You can check your property’s location on a Flood Insurance Rate Map at your building department or an insurance agent.

A few private insurance companies sell their own flood insurance policies, although the coverage and rates are different from the NFIP’s. Some mobile home insurance covers flood losses. Unlike the NFIP, private insurance will vary from company to company so check several for their coverage and rates.

If you are located in a floodplain shown on a Flood Insurance Rate Map, you must buy flood insurance coverage as a condition of having a mortgage or home improvement loan from a federally regulated lender or as a condition for getting federal disaster assistance. In some cases, private insurance will suffice for this requirement, but generally the lender or disaster assistance agency will ask to see an NFIP policy.

Don't wait.

Buy flood insurance protection before the next flood is threatening. There is a thirty-day waiting period before NFIP flood coverage takes effect. Contact your insurance agent for information on rates and coverage.

Flood Response Plan

Preparing a flood response plan will help you think through all the details that demand attention as the floodwaters approach. This is a project for the whole family. As you write down the plan, you can make sure everyone understands it. And having the plan in writing will help you remember what to do when everyone is in a hurry and excited because a flood is coming.

The next flood might be worse than the last one. Talk to your building official or city or county engineer about that possibility. See Step 8 for information on the flood protection level in your area to use as you prepare your flood response plan.

Check with your local emergency manager or Red Cross chapter for the official warning and evacuation procedures. Find out how much warning time you will have to leave your home before the flood reaches you. Identify a friend, relative, or motel where you can go when you are asked to evacuate. Test drive your evacuation route to be certain it will be passable when flooding is likely. Be prepared to evacuate when told to do so or if you see floodwaters rising. You may hear flood warning and evacuation information on your local TV and radio stations.

Make a record of all your personal property. Go through your home room by room recording household inventories and taking photographs or videotapes.

Inventory forms are available from most insurance companies, or you can use the format shown in Step 3. Keep photocopies of inventory records, insurance policies, deeds, and other valuable papers at a different location, someplace outside of the flood-prone area.

If flooding in your area is from sewer backup or basement, your own water alarm can give you precious lead time before your belongings are damaged by floodwaters. A water alarm is similar to a smoke alarm; it beeps when water touches it. Water alarms cost \$10 to \$20 and are available at hardware stores.

Develop a flood response plan based on the flood protection level, local warning procedures, and the time you will have to respond. In flash flood areas, you may only have enough time to evacuate. But if you live in areas in the path of a hurricane or on large rivers, you may have 12-24 hours of warning time.

Flash floods

If you live in a mountainous area, or if your flooding comes from a small stream or ditch, your home may be subject to flash flooding. Flash floods can occur before the local emergency managers have time to issue a warning. In these cases, the National Weather Service may issue a *flash flood watch* advising people that conditions are favorable for a flash flood. You may not be notified of a flash flood warning before flooding actually begins.

Flood Watch, Flood Warning

Floods can take several hours to days to develop.

- A *flood watch* means a flood is possible in your area.
- A *flood warning* means flooding is already occurring or will occur soon in your area.

Hurricanes

If you live near the coast, you will be asked to evacuate when a hurricane threatens your community. It is important to evacuate when you are asked to. Prepare your flood response plan to take into account all of the time that you will need to protect your home before you evacuate. You will need time to board your windows and to clear your yard so that your belongings will not blow or float away. You may also want to take time to move your belongings above the flood protection level. (See Step 8.)

Developing a checklist

Your flood response plan should be a checklist of steps to take before floodwaters reach your home. The following are examples of things to include:

- Listen to local radio or TV stations for flood information and evacuation instructions.
- Read safety precautions at the top of this document.
- Get into the habit of keeping a full tank of gas in your car, especially at times of the year when flooding can be expected in your area.
- Pack the car with supplies you need while away from home.
- Put supplies needed for clean up and recovery in a safe place. If your flood protection level is over your top floor, you may have to store supplies at a friend's home away from the flood-prone area or take them with you in your car.

- Take pets to a kennel or friend's place on high ground. Health codes do not allow animals in public shelters.
- If you have enough warning time, move your contents above the flood protection level or to another safe place. Some of the cost of doing this can be covered under an NFIP flood insurance policy.
- Install flood shields and other floodproofing measures you may have prepared.
- In hurricane-prone areas, protect against wind damage. Install hurricane shutters or plywood covers over windows and doors, take down TV antennas, and securely tie down boats, garbage cans, and everything else left outdoors.
- Tape plastic around the cap to your well. This will prevent most, but not all, floodwater from entering your water supply. You will still have to disinfect your water, as explained in Step 5.
- Turn off the electricity, gas, oil, and water.
- Lock your home.
- Follow your designated evacuation route to a place of shelter.

If You Are Asked To Evacuate

Take essential disaster supplies with you. See "Disaster Supplies Kit" on this web site.

Community activities

Your neighborhood or community can take steps to reduce flood losses in the future. Recent flooding may prompt local governments to

Flash Flood Watch

If it is raining a lot, or if you are in mountainous areas, it's a good idea to keep listening to local radio stations (not stations in locations away from where you are). If you hear a flash flood watch for your area, it's a good idea to stay on high ground.

If you hear a flash flood warning, climb to higher ground immediately. Leave your car, camping gear, or other belongings where they are. You may have only minutes to escape.

Flash floods can happen without warning. If you hear a rumbling sound, if animals are running away from where you are, or if you feel the ground shaking, climb to higher ground immediately.

start a flood planning effort that encourages citizens to participate. If no effort is underway, encourage your community leaders to get a flood protection program started.

There are many ways to reduce flood damage. a community flood protection program should consider a variety of activities. The obvious solution often seems to be “fixing” the shoreline or river using flood control projects such as dredging or seawalls.

Unfortunately, these activities may not be effective, feasible, or affordable without state or federal aid. Because flood control projects require so much planning, time, and money, communities should also consider and implement other approaches.

Keeping the ditches and drainageways open is very important. Trash, construction materials, shopping carts, and even grass clippings dumped in a ditch can clog bridges and culverts, and add to water pollution.

Neighborhood efforts to keep the ditches clean and to report dumpers can make a big difference in the amount of flooding, especially during smaller storms. Report illegal floodplain construction activities (i.e., those without a permit posted) to the building department.

You can work with your neighbors to monitor stream levels or rain gages to give the community advance warning. It may also be possible to monitor common debris catching sites, such as bridges, and keep the openings clear.

Sandbagging

Sandbagging can be very expensive. If your community wants to establish a plan for sandbagging, you will have to buy sandbags before a flood to be sure you have them on hand. Get burlap or plastic sandbags. Other kinds of bags simply won't hold up. Burlap or plastic bags cost 25¢ to 50¢ each. Sand and plastic sheeting must also be stockpiled.

Sandbagging can also be very time consuming. It takes two people approximately one hour to fill and place 100 sandbags, giving you a wall one foot high and 20 feet long. If you skimp on the bags, you risk putting up a wall that will be knocked over.

When a flood is imminent, everyone wants to sandbag, usually because they don't know what else to do. While it does have a therapeutic effect, sandbagging should be considered only as part of an overall flood response plan, or as a last resort for individuals.

A good plan will help use your limited time and resources most efficiently. For example, a flood response plan might call for sandbags to fill in gaps in a floodwall.

Sandbagging is supposed to keep water away from vulnerable flood-prone property. Floodproofing measures and moving contents out of the way are much more secure methods to accomplish the same thing. Therefore, before you consider sandbagging for your personal property, consider the flood protection alternatives discussed in Step 8. They are more effective and more dependable ways to protect a home from flooding.

Sources of information

The following people can provide advice or assistance on flood recovery. Some of these people may be able to speak to neighborhood groups or help in developing a community flood protection program.

Flood Preparedness and Safety

The American Red Cross and local emergency managers conduct sessions to increase public awareness and to educate the community in ways to prevent, prepare for, and cope with emergencies. Local emergency managers also sponsor public meetings on damage reduction, safety, response planning, how to handle stress, and other flood-related topics.

The following publications are available from the American Red Cross. Contact your Red Cross chapter for more information:

- *Your Family Disaster Plan* (ARC 4466)
- *Su plan para el hogar en caso de desastres* (ARC 4466S)
- *Your Family Disaster Supplies Kit* (ARC 4463)
- *Su Equipo de suministros para la familia en caso de desastres* (ARC 4463S)
- *Safe Living in Your Manufactured Home* (ARC 4465)
- *Are You Ready for a Flood or Flash Flood?* (ARC 4458)
- *¿Está preparado para una inundación or inundación súbita?* (ARC 4458S)
- *Are You Ready for a Hurricane?* (ARC 4454)
- *¿Está preparado para un huracán?* (ARC 4454S)

Clean up

Many Cooperative Extension Service offices have home economists and food and farm experts. Check your telephone book under the county name. For example, if you live in Pittsburg County, check under “Pittsburg County Cooperative Extension Service”.

Questions on cleaning or disinfecting of specific materials can be answered by manufacturers of cleaning products. Check the product labels for toll free telephone numbers.

Flood insurance

Your property insurance agent is the best source of information on flood insurance. He or she can give you forms and instructions for making your own property inventory. a free copy of *Answers to Questions about the National Flood Insurance Program*, FIA—2, is available from the Federal Emergency Management Agency. (See address below.)

Repairs and rebuilding

Local building and housing departments, and hardware stores are excellent sources of technical advice. Their staffs have many years of experience in dealing with local construction conditions. Home maintenance and repair books that are found in libraries or bookstores are invaluable references for the do-it-yourselfer.

Private home inspectors can give you itemized lists and cost estimates of needed repairs. (Look in the yellow pages under Building Inspection Services.) Building trades associations and the Better Business Bureau can provide guidance on dealing with contractors.

Floodproofing

Some local building officials and contractors are familiar with floodproofing techniques. Several states and communities have published floodproofing or “retrofitting” manuals. The Federal Emergency Management Agency and the U.S. Army Corps of Engineers have several publications that provide excellent summaries of various floodproofing measures. The following are available free from:

Federal Emergency
Management Agency
Attn: Publications
P. O. Box 2012
Jessup, MD 20794-2012

- *Design Manual for Retrofitting Flood-prone Residential Structures*, FEMA-114. This detailed manual explains all the floodproofing options in language a homeowner can understand.
- *Elevated Residential Structures*, FEMA-54.
- *Floodproofing Non-residential Structures*, FEMA-102.
- *Coastal Construction Manual*, FEMA-55.
- *Manufactured Home Installation in Flood Hazard Areas*, FEMA-85.

The following are available for free from:

U.S. Army Corps of Engineers
Attn: CECW-PF
20 Massachusetts Avenue, NW
Washington, D.C. 20314

- *Introduction to Flood Proofing*, John R. Sheaffer, 1967
- *Flood-Proofing Regulations*, U.S. Army Corps of Engineers, Pittsburgh District, 1990, 80 pages (Corps publication EP 1165 3 314).
- *Flood Proofing Systems & Techniques*, L.N. Flanagan, editor, 1984
- *Flood Proofing Tests, Tests of Materials and Systems for Flood Proofing Structures*, Corps of Engineers, National Flood Proofing Committee, August, 1988.
- *Raising and Moving the Slab-On-Grade House*, Corps of Engineers National Flood Proofing Committee, 1990.

References on technical aspects of floodproofing can be located through the Floodplain Management Resource Center, a free service provided by the Association of State Floodplain Managers. Call 303/492-6818 9:00 am - 4:00 pm, Mountain Time.

FEMA Regional Offices

Region I—
CT, ME, MA NH, RI, VT
FEMA Region I
J.W. McCormack POCH, Rm.
442
Boston, Massachusetts 02109-
4595
(617) 223-9561

Region II—

NJ, NY, PR, VI
 FEMA Region II
 26 Federal Plaza, Rm. 1337
 New York, NY 10278-0002
 (212) 225-7202

Region III—

DE, DC, MD, PA, VA, WV
 FEMA Region III
 Liberty Square Bldg., 2nd Floor
 105 S. Seventh Street
 Philadelphia, Pennsylvania
 19106-3392
 (215) 931-5750

Region IV—

AL, FL, GA, KY, MS, NC, SC, TN
 FEMA Region IV
 1371 Peachtree St., N.E., Suite
 700
 Atlanta, Georgia 30309-3108
 (404) 853-4400

Region V—

IL, IN, MI, MN, OH, WI
 FEMA Region V
 175 West Jackson Street, 4th Floor
 Chicago, Illinois 60604-2698
 (312) 408-5533

Region VI—

AR, LA, NM, OK, TX
 FEMA Region VI
 Federal Regional Center., Rm.
 206
 800 N. Loop 288
 Denton, Texas 76201-3698
 (817) 898-5127

Region VII—

IA, KS, MO, NE
 FEMA Region VII
 911 Walnut Street, Room 200
 Kansas City, Missouri 64106-
 2085
 (816) 283-7002

Region VIII—

CO, MT, ND, SD, UT, WY
 FEMA Region VIII
 Denver Regional Center
 Building 710, Box 25267
 Denver, Colorado 80225-0267
 (303) 235-4830

Region IX—

AZ, CA, HI, NV
 FEMA Region IX
 Building 105
 Presidio of San Francisco
 San Francisco, California 94129-
 1250
 (415) 923-7176

Region X—

AK, ID, OR, WA
 FEMA Region X
 Federal Regional Center
 130 228th St., S.W.
 Bothell, Washington 98021-9796
 (206) 487-4682

Index

A

Adjuster 11, 12, 16, 27, 28, 31-32
 Air Conditioning 10, 15, 39
 American Red Cross 2, 13, 25, 30, 46, 50
 Animals 3, 7 47
 Anxiety 1, 2, 35
 Appliances
 Cleaning 26-27
 Gas 21
 Protecting 38, 39

B

Baseboards 18, 19, 40
 Basement 20, 37, 38, 39, 40, 45
 Berms 37, 38
 Bleach 23, 24, 26, 27
 Books 7, 28
 Builders 41-42
 Building permit 35, 38-39

C

Cabinets 7, 15
 Calcium Chloride 16
 Carpet 12, 13, 16, 20, 26, 40
 Ceiling 6-7, 8, 13, 17-19
 Children 2
 Chimney 21
 Cleaning
 Advice 9-10, 25-29, 50
 Cleaners 26
 Supplies 25, 49
 Closets 15, 16
 Clothing, cleaning 27
 Community activities 49
 Computers 28
 Concrete 19, 40, 41
 Contractors 41-42
 Contracts 42
 Cosmetics 16

Counseling 2, 33-34
 Crawl space 10, 20
 Credit Cards 13-14
 Crisis counseling 2, 33-34

D

Dampness 15
 Dehumidifier 15
 Depression 1
 Desiccants 15-16
 Disaster assistance 32-34
 Dishes, cleaning 3, 27
 Disinfectants 26
 Drywall, *see* Wallboard
 Drying 15-20
 Ducts, heating or cooling 10-15

E

Electrical system
 Circuit breakers 5, 13, 22-23
 Cleaning 9-10, 22
 Electricity safety 22
 Fuse boxes 5, 13, 22-23
 Turning off 5
 Turning on 22-23
 Elevation 36
 Evacuation supplies 48

F

Fatigue 1-3
 Financial assistance 13, 30-34
 Flash floods 46-47
 Flood insurance 7-8, 21, 44-46
 Claims 11, 12, 31-32
 References 51
 Flood protection
 Community activities 49
 Emergency steps 47
 Flood response plan 46-49
 Flood proofing 13, 35-41
 Assistance 33
 References 51

Flood protection level 35, 36, 37, 38, 29, 44
 Flood response plan 46-49
 Flood warning 46
 Flood watch 46
 Floodwall 37, 38, 39, 44, 49
 Floor 8, 12, 13, 20, 40
 See also Carpet
 Flooring 20, 40, 41, 51
 See also Carpet
 Foam rubber 16, 20
 Food 11, 16-17, 27-28, 48
 Foundation 5, 12, 13, 20, 36, 37, 38, 45
 Fuel oil 6, 21
 Furnace 15, 21, 38, 39, 45
 Furniture 10, 13, 16, 26, 38, 44
 Cleaning 26

G

Garbage 16-17, 28
 Gas system, 6, 13, 21
 Checking for leaks 5, 21
 Gas meter 6
 Turning off 5-6
 Turning on 21
 Generators 4
 Government assistance 32-34
 Grants 33
 Grass 28
 Gypsum board, *see* Wallboard

H

Health precautions 1-3, 9
 Humidity 15-16
 Hurricanes 41, 46, 47
 References 50

I

Income tax 11, 33
Information sources of 50-53
Insulation 17, 18, 19, 20, 40, 41
Insurance
 Agent 11, 16
 See also Adjuster
 Coverage 11
 Flood 7-8, 21, 31-32, 44-46
 Homeowner's 11
 Wind and hail 11
Inventory 12, 46, 48

K

Kitchen ware 27

L

Lawn 28
Leather cleaning 13, 27
Levee 37, 49
Lights, *see* Electrical system,
 Appliances
Linoleum 41
 See also Flooring
Loans, disaster 30, 33
LP gas, *see* Gas system

M

Mattresses 16
Medicine 16, 48
Mildew 7, 15, 16, 25, 26, 27
Mildew-resistant paint 40
Mobile (manufactured) home 44,
 45
Mold, *see* Mildew
Mortgage holder 13, 32, 38
Mosquitoes 28
Moth crystals 28
Mud 5, 7, 9-10, 15, 17, 20, 22,
 27, 28-29

N

National Flood Insurance
 Program, 44-46

O

Oil, *see* Gas system
Outlets, *see* Electrical system
Outreach programs 1-2

P

Paint 40-41
Paneling 20, 41
Permit, building 35, 38-39
Pets, *see* Animals
Photographs 7, 28
Plan for recovery 11-14
Plants 29
Plaster 6, 17, 18, 19
Plywood 17-18, 40, 41, 47
 See also Wood, Floors,
 Paneling, Windows
Power, *see* Electrical system
Prescriptions 48
Proof of Loss 12, 31-32
Propane, *see* Gas system

R

Rebuilding, *see* repairs
Records 11-12, 16, 28, 46
Recovery plan 11-14
Regulations, *see* Building code
Red Cross, *see* American Red
 Cross
References 50-53
Repairs 35-43
 Temporary 7-8
Roof 8
Rugs, *see* Carpet

S

Safety checklist 6
Sandbags 49
Septic system 24
Sewage disposal 24
Sheetrock, *see* wallpaper
Stress 1-2
Structural damage 12, 38
Substantially damaged,
 definition 38

T

Tile 20, 40
Toys 2, 16
Trash, *see* Garbage

U

Unheated. *See* Winterizing
Utilities. *See also* Electrical system,
 Gas system, Water supply
 Restoring 21-24

V

Valuables 7
Video 11, 16, 46
 Camera 5
Volunteer organizations 30

W

Walls 7, 8, 12, 13, 17, 41
 Basement 8-9, 45
 Drying 13, 17, 18, 19
 Cleaning 10, 25, 40
 Protecting 37
 References 51
Wall covering 19, 41
Wallboard 6, 7, 13, 15, 17, 18,
 19, 40, 41
 Cleaning 25
Wallpaper, *see* Wall covering
Warnings 46, 47, 49
Water, drinking 3, 5, 8, 23-24
Water alarm 46
Water heater 21, 24, 38, 39
Waterproofing 37, 39, 41
Water supply 8, 10, 23-24
Well water 24, 47-48
Windows 8
 Cleaning 25
Winterizing 24
Wires, wiring, *see* Electrical
 system
Wood 16, 17-18, 26, 39, 40
 See also Walls, Floors, Furniture,
 Cabinets

Important Numbers

Police	Insurance Agent
Fire	Homeowner's Insurance Policy Company Number
Ambulance	
Emergency Management Office	Flood Insurance Policy Company Number
Neighbors	Wind and/or Hail Insurance Policy Company Number
American Red Cross	
Power Company	Disaster Hotline (announced if there is a federal disaster declaration)
Gas Company	Hardware Stores
Water	Lumber Companies
Health Department	Cooperative Extension Service
Poison Control Center	

F L O O D S A F E T Y

Do not walk through flowing water. Drowning is the number one cause of flood deaths. Most of these drownings occur during flash floods. Six inches of moving water can knock you off your feet. Use a pole or stick to make sure that the ground is still there before you go through an area where the water is not flowing.

Do not drive through a flooded area. More people drown in their cars than anywhere else. Don't drive around road barriers; the road or bridge may be washed out.

Stay away from power lines and electrical wires. Electrocutation is also a major killer in floods. Electrical current can travel through water. Report downed power lines to your utility company or local emergency manager.

Turn off your electricity when you return home. Follow the instructions in Step 2. Some appliances, such as television sets, can shock you even after they have been unplugged. Don't use appliances or motors that have gotten wet unless they have been taken apart, cleaned, and dried.

Watch for animals, especially snakes. Small animals that have been flooded out of their homes may shelter in yours. Use a pole or stick to seek poke and turn items over and scare away small animals.

Look before you step. After a flood, the ground and floors are covered with debris including broken bottles and nails. Floors and stairs that have been covered with mud can be very slippery.

Be alert for gas leaks. Use a flashlight to inspect for damage. Don't smoke or use candles, lanterns, or open flames unless you are sure that the gas has been turned off and the area has been aired out. Carbon monoxide exhaust kills. Use a generator or other gasoline-powered machine outdoors. The same goes for camping stoves. Fumes from charcoal are especially deadly-cook with charcoal only outdoors.

Clean everything that got wet. Floodwaters have picked up sewage and chemicals from roads, farms, factories, and storage buildings. Spoiled food and flooded cosmetics and medicines are health hazards. When in doubt throw them out.

Take good care of yourself. Recovering from a flood is a big job. It is tough on both the body and the spirit. And the effects a disaster has on you and your family may last a long time. Read Step 1 on how to recognize and care for anxiety, stress, and fatigue.

*Issued in furtherance of the International Decade
for Natural Disaster Reduction.*